

# FHX04X, FHX05X, FHX06X

GaAs FET & HEMT Chips

## FEATURES

- Low Noise Figure: 0.75dB (Typ.)@f=12GHz (FHX04)
- High Associated Gain: 10.5dB (Typ.)@f=12GHz
- $L_g \leq 0.25\mu\text{m}$ ,  $W_g = 200\mu\text{m}$
- Gold Gate Metallization for High Reliability

## DESCRIPTION

The FHX04X, FHX05X, FHX06X are High Electron Mobility Transistors (HEMT) intended for general purpose, low noise and high gain amplifiers in the 2-18GHz frequency range. The devices are well suited for telecommunication, DBS, TVRO, VSAT or other low noise applications.

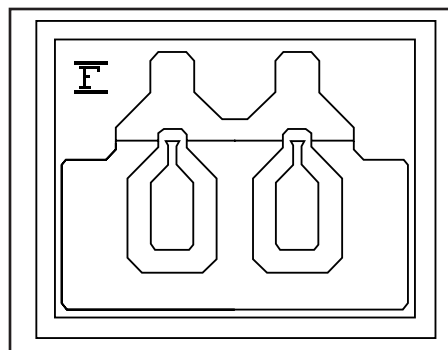

Eudyna's stringent Quality Assurance Program assures the highest reliability and consistent performance.

## ABSOLUTE MAXIMUM RATING (Ambient Temperature $T_a=25^\circ\text{C}$ )

Item	Symbol	Rating	Unit
Drain-Source Voltage	$V_{DS}$	3.5	V
Gate-Source Voltage	$V_{GS}$	-3.0	V
Total Power Dissipation	$P_t^*$	180	mW
Storage Temperature	$T_{stg}$	-65 to +175	$^\circ\text{C}$
Channel Temperature	$T_{ch}$	175	$^\circ\text{C}$

\*Note: Mounted on  $\text{Al}_2\text{O}_3$  board (30 x 30 x 0.65mm)

Eudyna recommends the following conditions for the reliable operation of GaAs FETs:

1. The drain-source operating voltage ( $V_{DS}$ ) should not exceed 2 volts.
2. The forward and reverse gate currents should not exceed 0.2 and -0.05 mA respectively with gate resistance of 4000 $\Omega$ .
3. The operating channel temperature ( $T_{ch}$ ) should not exceed 80 $^\circ\text{C}$ .

## ELECTRICAL CHARACTERISTICS (Ambient Temperature $T_a=25^\circ\text{C}$ )

Item	Symbol	Test Conditions	Limit			Unit
			Min.	Typ.	Max.	
Saturated Drain Current	$I_{DSS}$	$V_{DS} = 2\text{V}$ , $V_{GS} = 0\text{V}$	15	30	60	mA
Transconductance	$g_m$	$V_{DS} = 2\text{V}$ , $I_{DS} = 10\text{mA}$	35	45	-	mS
Pinch-off Voltage	$V_p$	$V_{DS} = 2\text{V}$ , $I_{DS} = 1\text{mA}$	-0.2	-0.7	-1.5	V
Gate Source Breakdown Voltage	$V_{GSO}$	$I_{GS} = -10\mu\text{A}$	-3.0	-	-	V
Noise Figure	FHX04X	NF	-	0.75	0.85	dB
Associated Gain			$G_{as}$	9.5	10.5	-
Noise Figure	FHX05X	NF	-	0.9	1.1	dB
Associated Gain			$G_{as}$	9.5	10.5	-
Noise Figure	FHX06X	NF	-	1.1	1.35	dB
Associated Gain			$G_{as}$	9.5	10.5	-
Maximum Available Gain	$G_a(\text{max})$	Same as above, Gain matched	11.0	12.0	-	dB
Thermal Resistance	$R_{th}$	Channel to Case	-	220	300	$^\circ\text{C/W}$

Note: RF parameter sample size 10pcs. criteria (accept/reject)=(2/3)

The chip must be enclosed in a hermetically sealed environment for optimum performance and reliability.

# FHX04X, FHX05X, FHX06X

GaAs FET & HEMT Chips

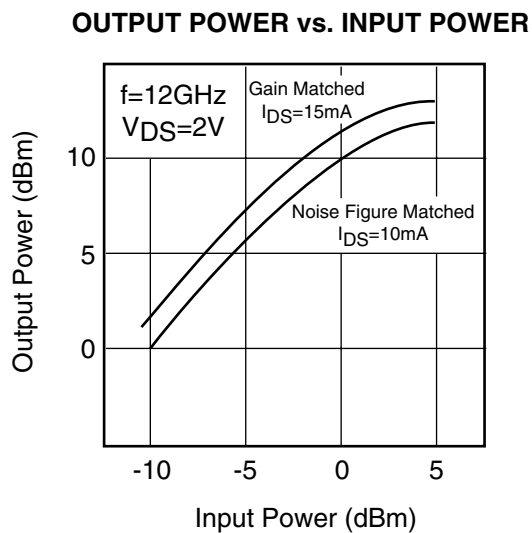
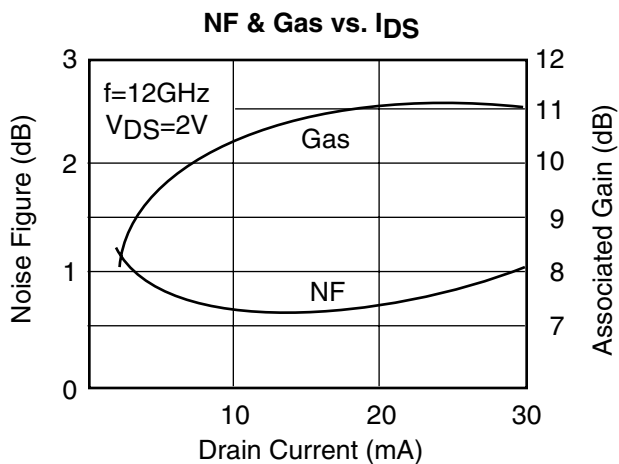
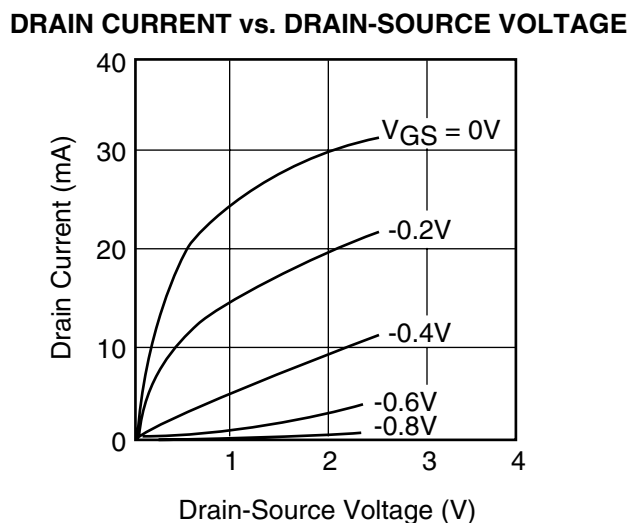
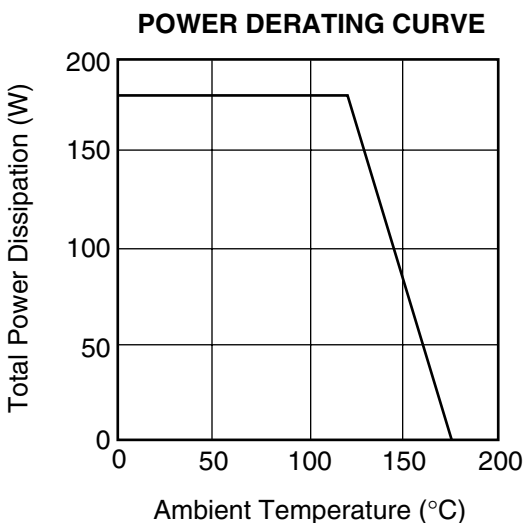

# FHX04X, FHX05X, FHX06X

## GaAs FET & HEMT Chips

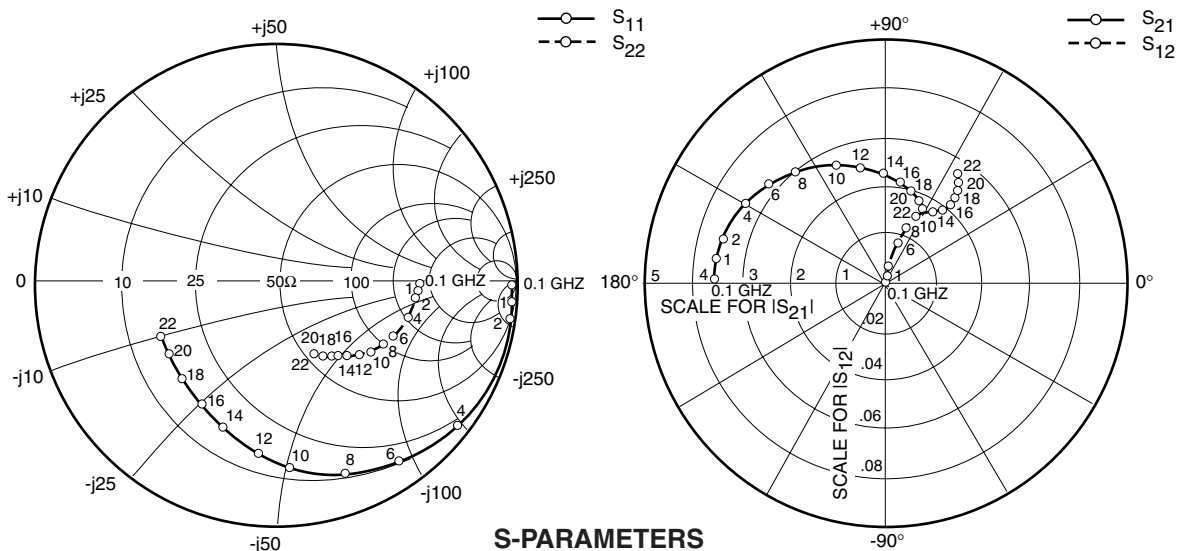

### S-PARAMETERS

$V_{DS} = 2V, I_{DS} = 10mA$

FREQUENCY (MHZ)	S11		S21		S12		S22	
	MAG	ANG	MAG	ANG	MAG	ANG	MAG	ANG
100	1.000	-0.9	3.721	179.2	.001	89.5	.606	-0.4
500	.999	-4.7	3.717	176.0	.007	87.7	.605	-2.1
1000	.996	-9.5	3.705	172.0	.013	86.4	.604	-4.2
2000	.983	-18.8	3.658	164.1	.026	81.0	.598	-8.3
4000	.928	-37.0	3.489	149.0	.049	72.3	.576	-16.0
6000	.877	-54.0	3.255	135.1	.068	66.0	.547	-22.9
8000	.811	-59.3	2.999	122.5	.082	60.3	.516	-28.9
10000	.748	-84.5	2.750	111.2	.093	57.3	.485	-34.2
12000	.694	-98.2	2.521	101.1	.101	55.2	.457	-39.1
14000	.649	-111.1	2.319	92.0	.108	54.6	.432	-43.7
16000	.614	-123.2	2.142	83.5	.114	55.0	.410	-48.4
18000	.588	-134.6	1.988	75.9	.121	56.2	.391	-53.2
20000	.570	-145.4	1.853	68.8	.130	57.8	.373	-58.4

NOTE:\* The data includes bonding wires.

n: number of wires

Gate n=2 (0.3mm length, 20um Dia Au wire)

Drain n=2 (0.3mm length, 20um Dia Au wire)

Source n=4 (0.3mm length, 20um Dia Au wire)

### Ga (max) & $|S_{21}|^2$ vs. FREQUENCY

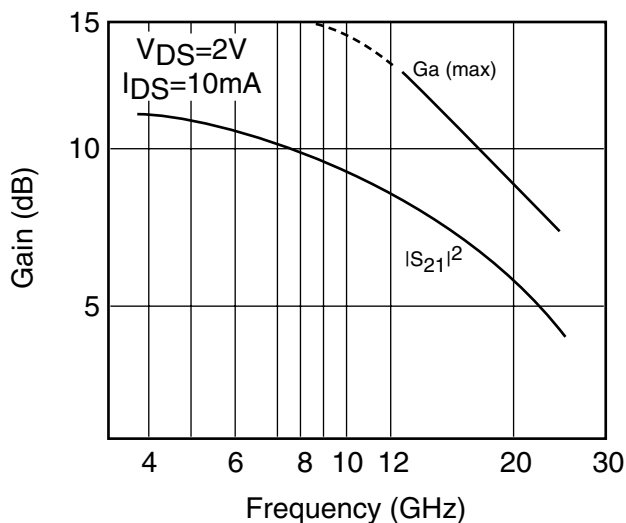

### NOISE PARAMETERS

$V_{DS}=2V, I_{DS}=10mA$

Freq. (GHz)	$\Gamma_{opt}$		NFmin (dB)	Rn/50
	(MAG)	(ANG)		
2	0.80	16	0.33	0.50
4	0.74	31	0.35	0.45
6	0.68	46	0.44	0.40
8	0.63	61	0.53	0.30
10	0.58	75	0.63	0.23
12	0.52	89	0.72	0.18
14	0.47	102	0.84	0.14
16	0.42	114	0.97	0.12
18	0.38	126	1.09	0.10
20	0.33	137	1.22	0.09

# FHX04X, FHX05X, FHX06X

## GaAs FET & HEMT Chips

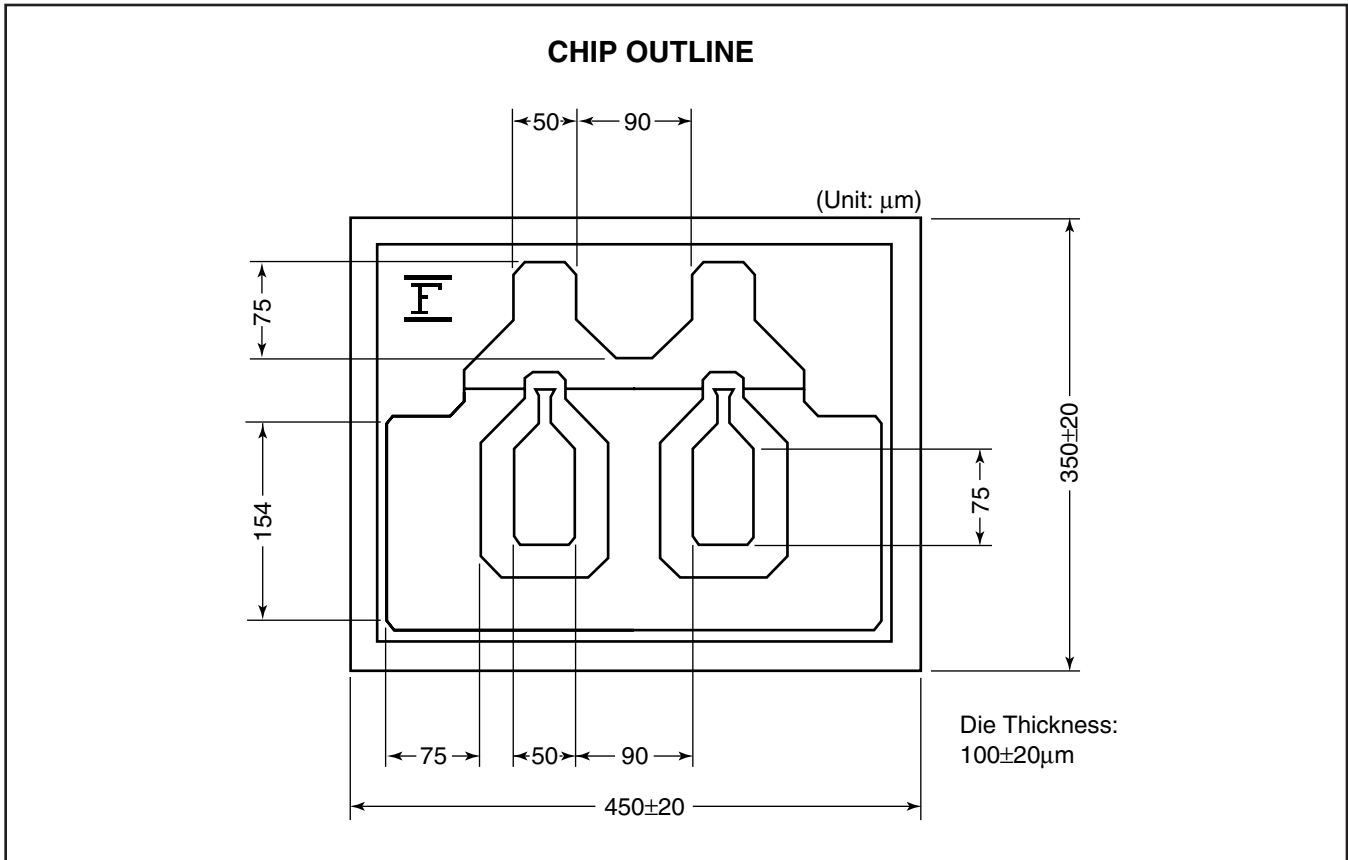

For further information please contact:

### Eudyna Devices USA Inc.

2355 Zanker Rd.  
San Jose, CA 95131-1138, U.S.A.  
TEL: (408) 232-9500  
FAX: (408) 428-9111  
[www.us.eudyna.com](http://www.us.eudyna.com)

### Eudyna Devices Europe Ltd.

Network House  
Norreys Drive  
Maidenhead, Berkshire SL6 4FJ  
United Kingdom  
TEL: +44 (0) 1628 504800  
FAX: +44 (0) 1628 504888

### Eudyna Devices Asia Pte Ltd.

Hong Kong Branch  
Rm. 1101, Ocean Centre, 5 Canton Rd.  
Tsim Sha Tsui, Kowloon, Hong Kong  
TEL: +852-2377-0227  
FAX: +852-2377-3921

### Eudyna Devices Inc.

Sales Division  
1, Kanai-cho, Sakae-ku  
Yokohama, 244-0845, Japan  
TEL: +81-45-853-8156  
FAX: +81-45-853-8170

### CAUTION

Eudyna Devices Inc. products contain **gallium arsenide (GaAs)** which can be hazardous to the human body and the environment. For safety, observe the following procedures:

- Do not put this product into the mouth.
- Do not alter the form of this product into a gas, powder, or liquid through burning, crushing, or chemical processing as these by-products are dangerous to the human body if inhaled, ingested, or swallowed.
- Observe government laws and company regulations when discarding this product. This product must be discarded in accordance with methods specified by applicable hazardous waste procedures.

Eudyna Devices Inc. reserves the right to change products and specifications without notice. The information does not convey any license under rights of Eudyna Devices Inc. or others.

© 2004 Eudyna Devices USA Inc.  
Printed in U.S.A.

# Eudyna