

FMM5059VU

Ku-Band Power Amplifier MMIC

FEATURES

- High Output Power: Pout=33.5dBm (typ.)
- High Linear Gain: GL=30dB (typ.)
- Impedance Matched Zin/Zout=50Ω
- Small Hermetic Metal-Ceramic SMT Package(VU)

DESCRIPTION

The FMM5059VU is a MMIC amplifier that contains a three-stages amplifier, internally matched, for standard communications band in the 13.75 to 14.5GHz frequency range. This product is well suited for VSAT applications as it offers high power, high gain, and low distortion. Eudyna Devices's stringent Quality Assurance Program assures the highest reliability and consistent performance.



ABSOLUTE MAXIMUM RATING

Item	Symbol	Rating	Unit
Drain-Source Voltage	VDD	10	V
Gate-Source Voltage	VGG	-3	V
Input Power	Pin	26	dBm
Storage Temperature	Tstg	-55 to +125	°C

<note>

Semiconductor devices can be permanently damaged by application of stress (voltage, current, temperature, etc.) in excess of absolute maximum ratings. Do not exceed these ratings.

RECOMMENDED OPERATING CONDITIONS

Item	Symbol	Condition	Unit
Drain-Source Voltage	VDD	≤6	V
Input Power	Pin	≤12	dBm
Operating Case Temperature	Tc	-40 to +85	°C

ELECTRICAL CHARACTERISTICS (Case Temperature Tc=25°C)

Item	Symbol	Test Conditions	Limits			Unit
			Min.	Typ.	Max.	
Frequency Range	f	VDD=6.0V	13.75	-	14.5	GHz
Gate Bias Voltage	VGG(DC)	IDD(DC)=1200mA typ.	-0.01	-0.1	-0.5	V
Output Power at 1dB G.C.P.	P1dB	ZS=ZL=50ohm	32.5	33.5	-	dBm
Power Gain at 1dB G.C.P.	G1dB		25	29	-	dB
Gain Flatness	DG		-	1.5	2	dB
Power-added Efficiency at 1dB G.C.P.	Nadd		-	27	-	%
Third Order Intermodulation Distortion	IM3*	*delta f=10MHz	-26	-28	-	dBc
Drain Current at 1dB G.C.P.	I _{dsr}	2-tone Test	-	1400	1700	mA
Input Return Loss	R.L-In	Pout=25.5dBm S.C.L	-	-6	-	dB
Output Return Loss	R.L-Out		-	-10	-	dB

1dB G.C.P. : 1dB Gain Compression Point

S.C.L. : Single Carrier Level

ESD	Class 0	~ 250V
------------	----------------	---------------

Note: Based on JEDEC JESD22-A114-C

CASE STYLE	VU
-------------------	-----------

RoHS Compliance	Yes
------------------------	------------

FMM5059VU

Ku-Band Power Amplifier MMIC

Frequency vs. Output Power

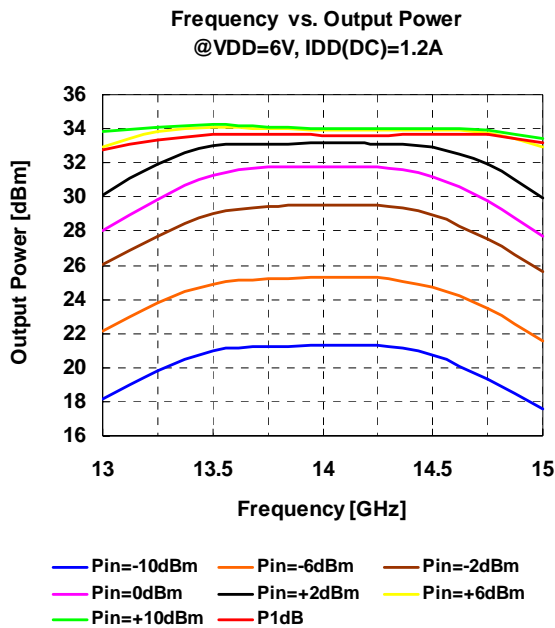

Frequency vs. Power Added Efficiency

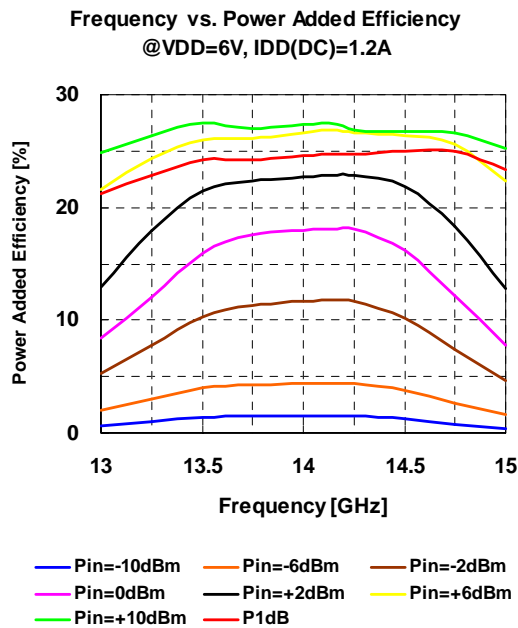

Input Power vs. Output Power

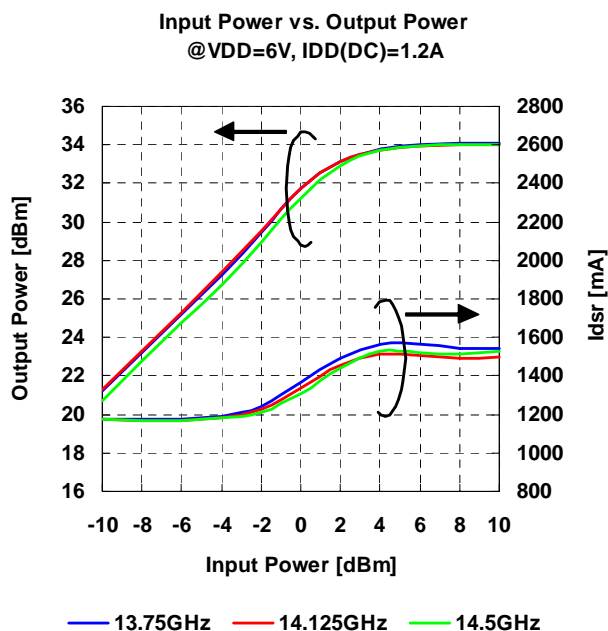

Total Output Power vs. IMD

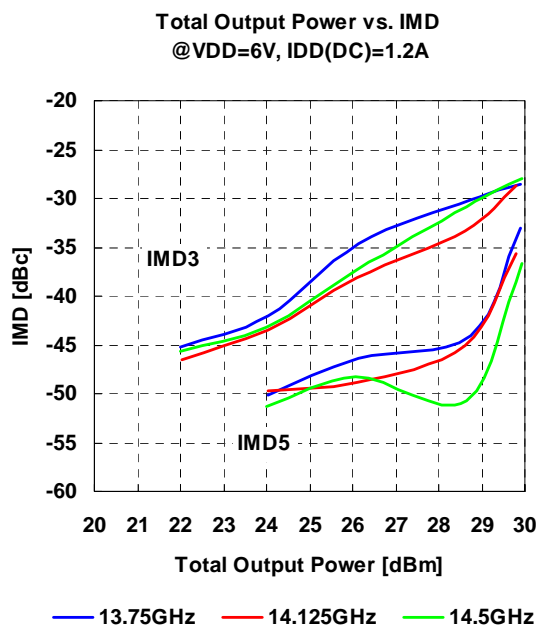

FMM5059VU

Ku-Band Power Amplifier MMIC

Output Power, Drain Current, IMD vs. Input Power by Drain Voltage

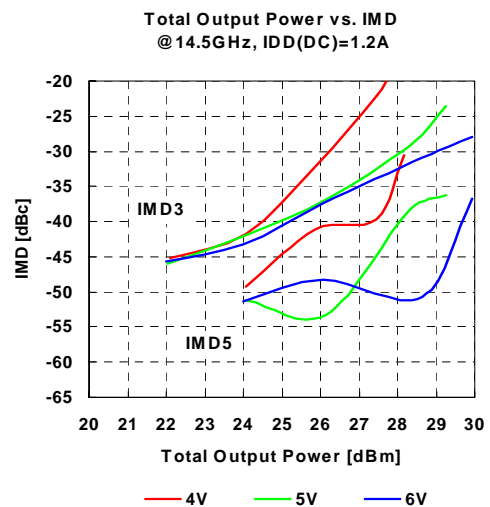
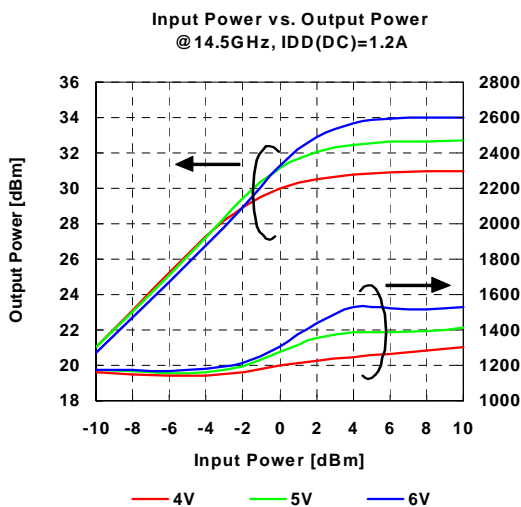
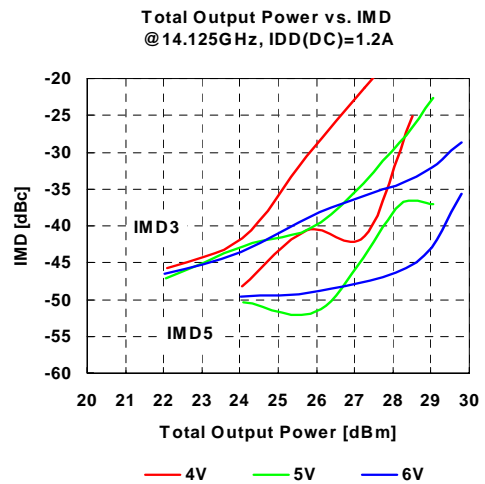
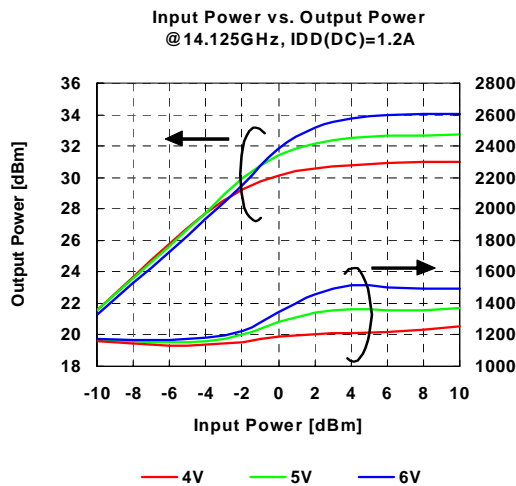
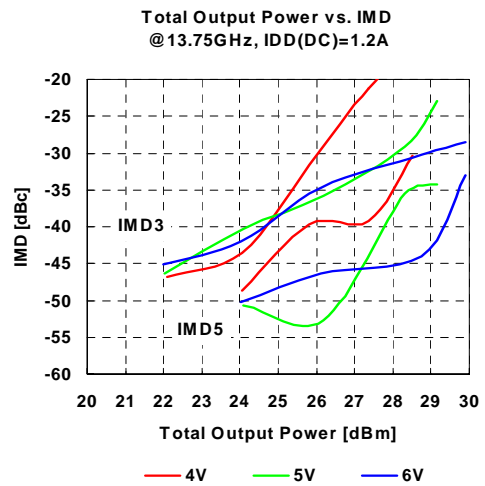
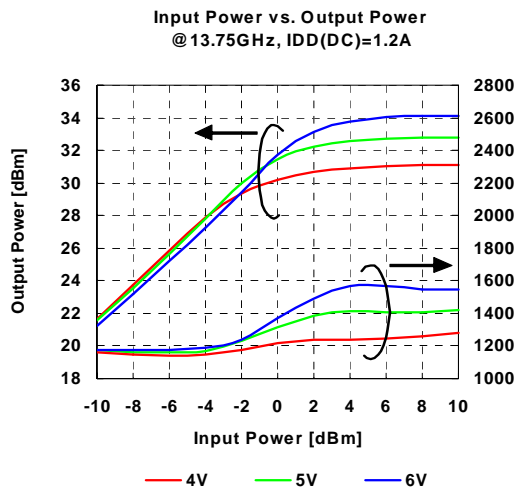

FMM5059VU

Ku-Band Power Amplifier MMIC

Output Power, Drain Current, IMD vs. Input Power by Drain Current

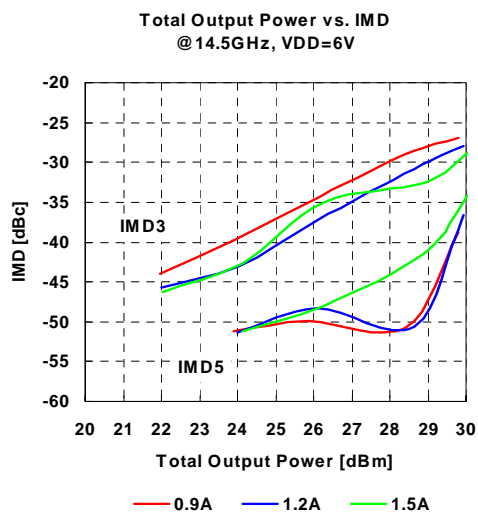
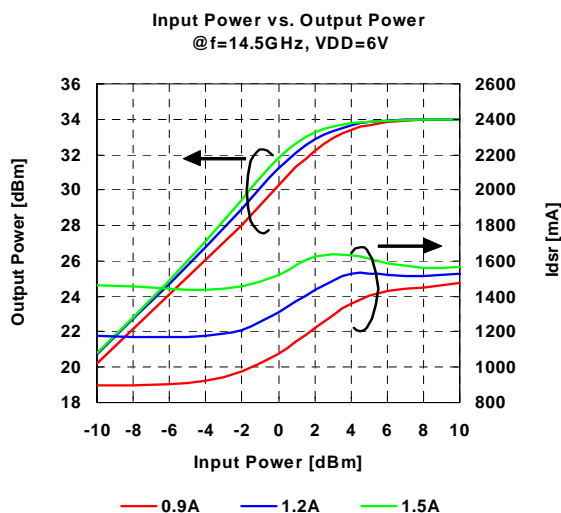
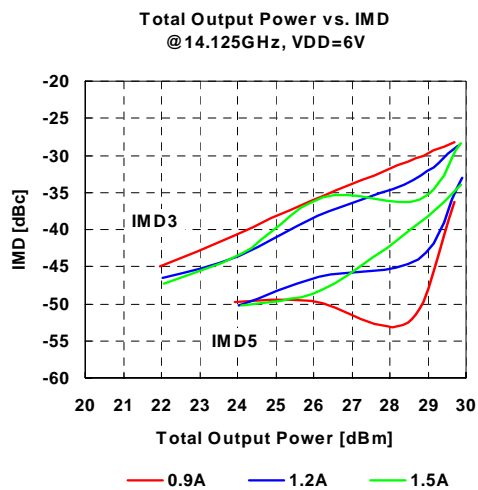
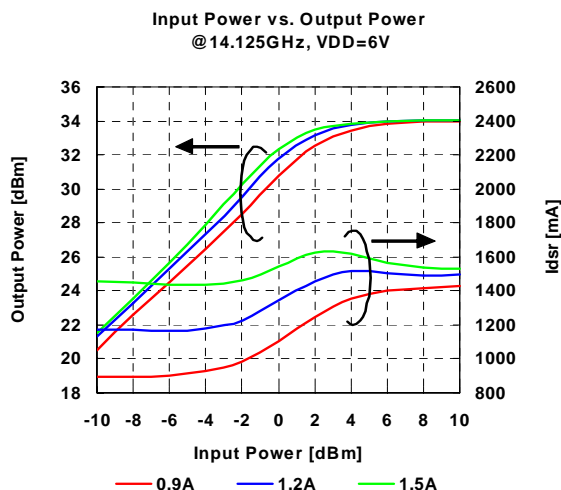
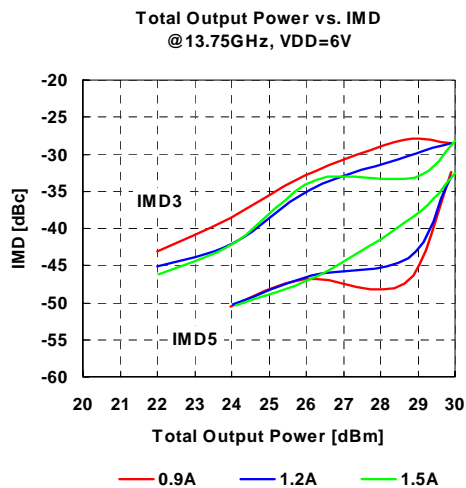
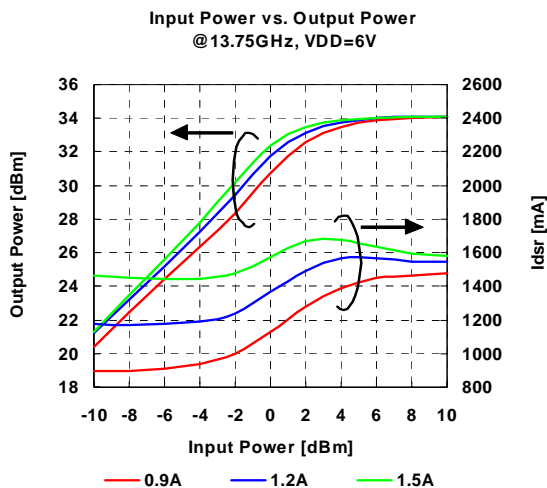

FMM5059VU

Ku-Band Power Amplifier MMIC

S-parameter @VDD=6V, IDD(DC)=1.2A

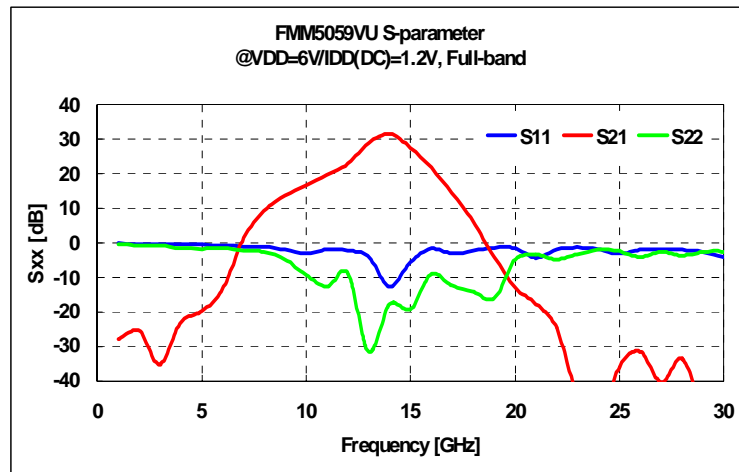

Freq. [GHz]	S11 MAG	S11 ANG	S21 MAG	S21 ANG	S12 MAG	S12 ANG	S22 MAG	S22 ANG
0.1	9.99E-01	-13.47	1.19E-03	-0.994	1.82E-04	-65.114	1.00E+00	-14.393
1	9.90E-01	-136.711	4.00E-02	-68.031	7.08E-05	54.838	9.80E-01	-145.306
2	9.58E-01	87.994	5.39E-02	-57.282	6.95E-05	-24.869	9.24E-01	75.768
3	9.60E-01	-44.35	1.73E-02	-150.612	2.15E-04	-143.142	9.26E-01	-58.636
4	9.59E-01	-178.227	7.07E-02	74.114	6.29E-04	72.146	8.40E-01	144.478
5	9.43E-01	43.411	1.03E-01	-69.104	7.50E-04	-52.504	8.23E-01	18.194
6	9.12E-01	-90.179	2.13E-01	159.952	4.95E-04	172.255	8.38E-01	-97.348
7	9.00E-01	139.491	1.16E+00	1.081	5.22E-04	44.888	7.89E-01	116.95
8	8.94E-01	-0.848	2.95E+00	147.741	2.87E-04	119.845	7.37E-01	-42.813
9	7.92E-01	-140.939	4.86E+00	-56.344	3.56E-04	105.216	5.75E-01	164.616
10	7.18E-01	82.608	6.90E+00	103.037	9.97E-04	-71.291	3.48E-01	-31.65
11	8.00E-01	-48.901	9.58E+00	-92.581	9.43E-04	137.228	2.33E-01	90.518
12	7.74E-01	178.748	1.41E+01	73.835	9.53E-04	-1.868	3.63E-01	-69.855
13	6.33E-01	28.997	2.81E+01	-136.098	6.73E-04	-158.413	2.65E-02	110.585
14	2.32E-01	-153.46	3.88E+01	-24.923	4.02E-04	105.396	1.31E-01	-79.543
15	5.35E-01	-158.725	2.40E+01	79.606	1.18E-03	-50.388	1.10E-01	-108.47
16	8.30E-01	73.014	1.23E+01	-139.028	2.18E-03	160.735	3.52E-01	-118.959
17	7.07E-01	-59.45	5.26E+00	1.532	1.57E-03	17.004	2.39E-01	154.348
18	7.78E-01	146.769	2.08E+00	138.106	3.78E-03	167.738	1.98E-01	145.527
19	8.57E-01	24.465	6.39E-01	-56.001	6.68E-03	-76.07	1.58E-01	-41.88
20	8.47E-01	-73.221	2.27E-01	123.281	1.11E-02	105.716	5.69E-01	173.813
21	6.11E-01	143.83	1.31E-01	-60.674	2.21E-02	-59.419	6.78E-01	77.277
22	7.98E-01	-23.041	5.89E-02	79.672	1.29E-02	73.492	5.75E-01	-45.396
23	8.64E-01	-121.292	6.03E-03	-107.564	5.99E-03	-51.002	6.94E-01	133.657
24	8.08E-01	149.877	2.48E-03	168.533	2.88E-03	-131.109	7.93E-01	25.944
25	7.02E-01	-11.463	1.61E-02	114.383	1.80E-02	113.94	7.59E-01	-70.051
26	7.98E-01	-177.955	2.68E-02	-73.905	2.64E-02	-76.863	6.25E-01	123.338
27	8.15E-01	86.278	9.59E-03	160.977	1.50E-02	147.756	7.51E-01	-12.771
28	7.91E-01	-4.608	2.10E-02	1.304	1.71E-02	0.709	6.59E-01	-106.442
29	7.54E-01	-140.255	4.46E-03	-134.036	3.19E-03	-123.947	7.44E-01	147.783
30	6.17E-01	43.562	3.80E-03	154.147	3.44E-03	126.299	7.45E-01	-0.449

FMM5059VU

Ku-Band Power Amplifier MMIC

ΔT_{ch} vs. MTTF

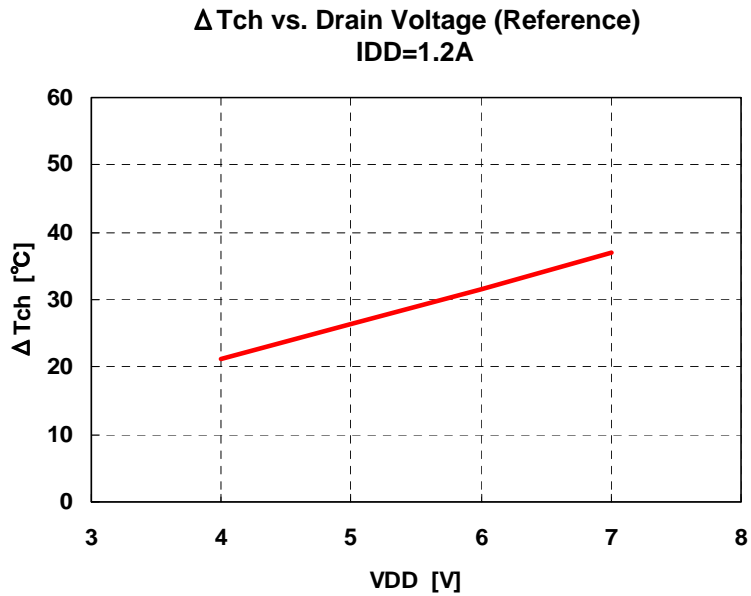

Note: ΔT_{ch} : Temperature Rise from Backside of the Package to Channel.

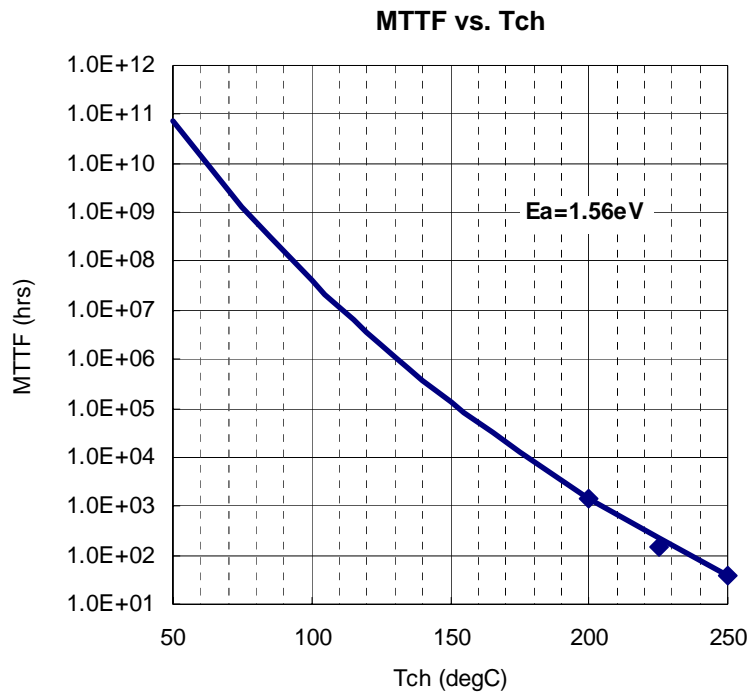

FMM5059VU

Ku-Band Power Amplifier MMIC

Block Diagram

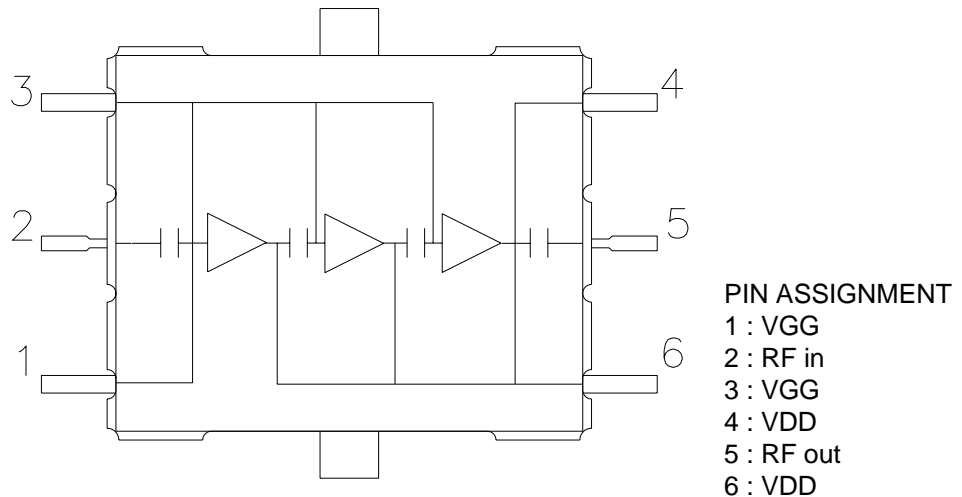

Recommended Bias Circuit

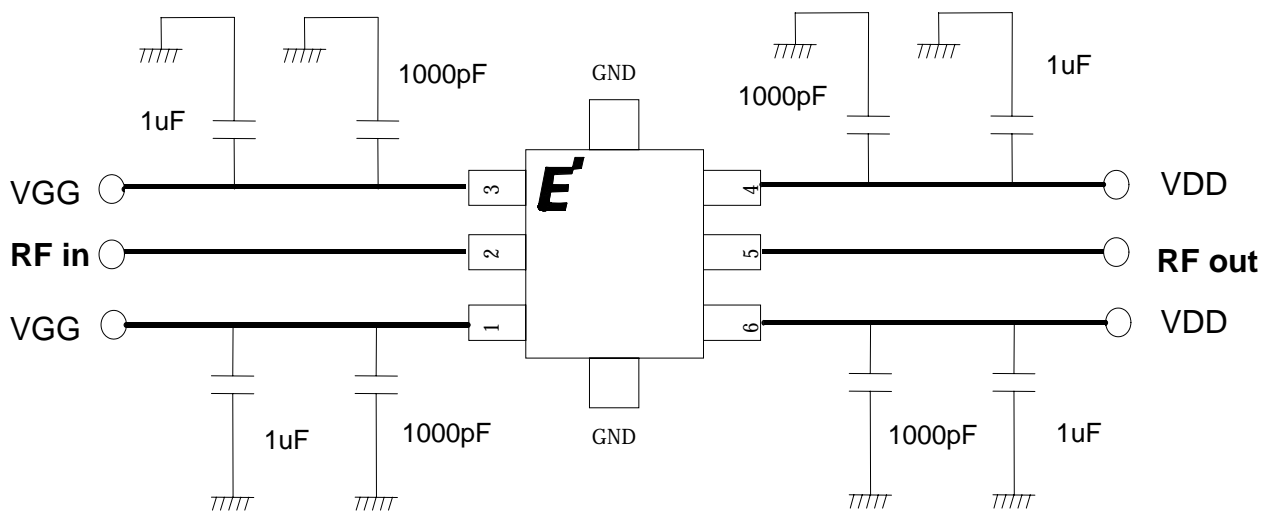

Note 1: The capacitors are recommended on the bias supply line, close to the package, in order to prevent video oscillations which could damage the module.

Note 2: Two pins named VGG are internally connected.

The VGG can be supplied from either of the pins, No.1 or No.3.

Note 3: Two pins named VDD are internally connected.

The VDD can be supplied from either of the pins, No.4 or No.6.

FMM5059VU

Ku-Band Power Amplifier MMIC

VU Package Dimensions

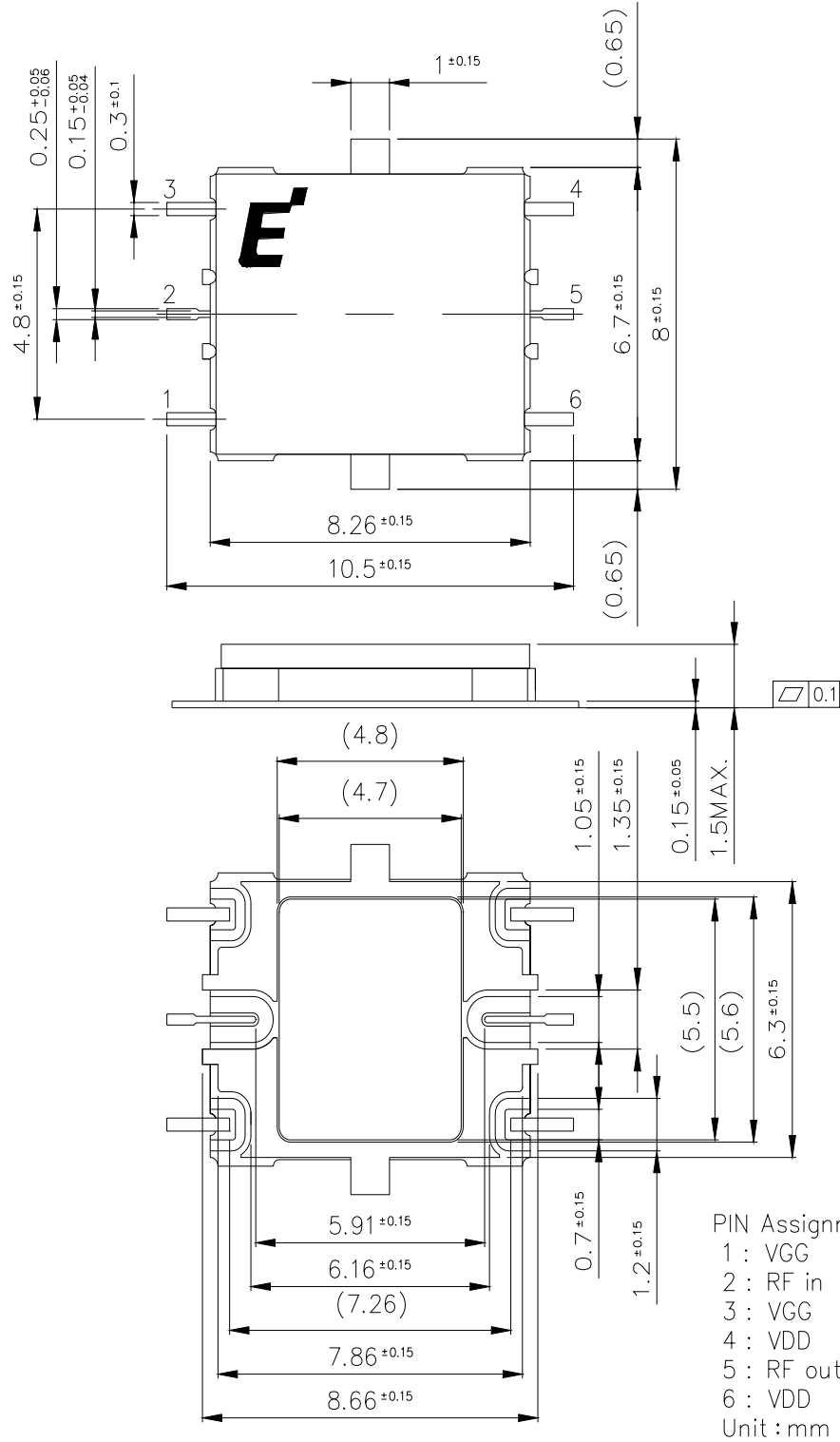

FMM5059VU

Ku-Band Power Amplifier MMIC

PCB, Bias Circuit, and Solder Resist Pattern (Recommended)

■ PCB and Bias Circuit

■ Solder Resist Pattern

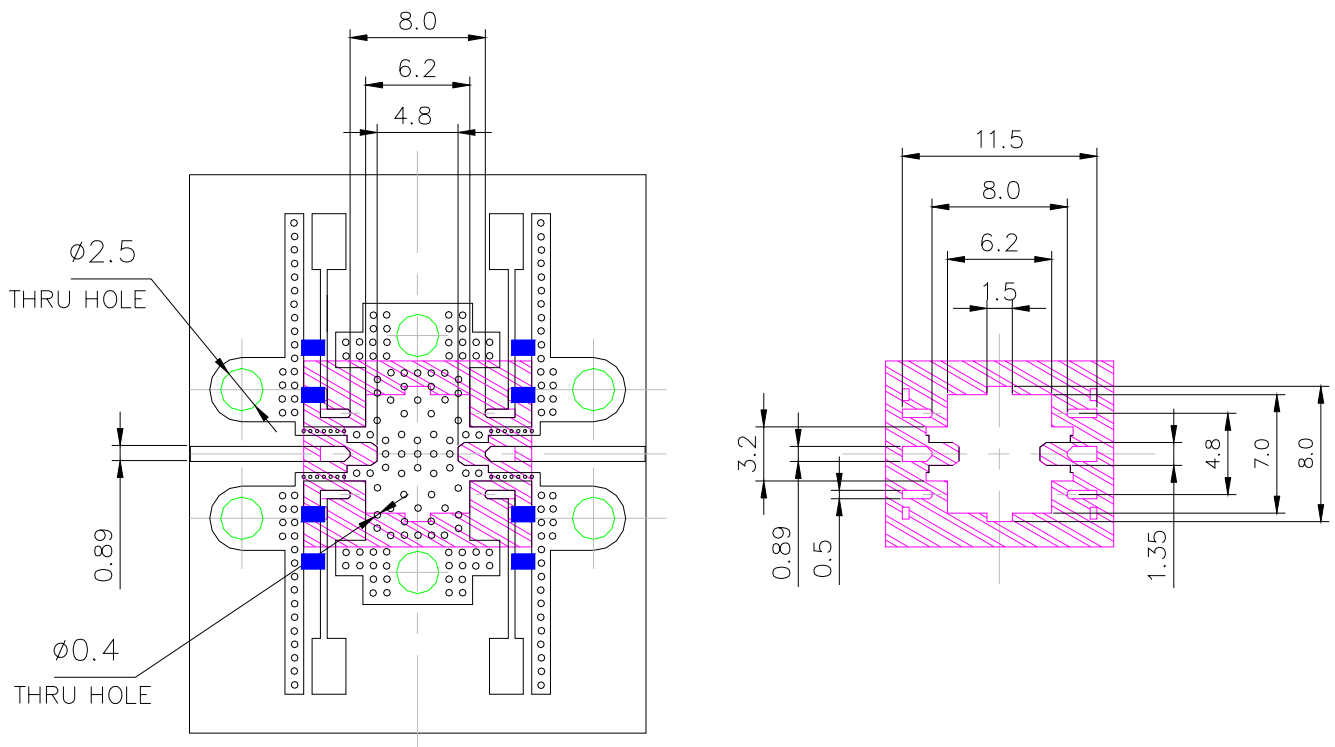

Notes

Material : DICLAD552-B-013-55-60
Thickness = 0.3mm (Typ.), Er = 2.6 (Typ.)
Copper Foil Thickness = 18um (Typ.), Top and Bottom Sides
Ni/Au Plating (Ni= 1um min., Au 0.1um max.)

FMM5059VU

Ku-Band Power Amplifier MMIC

Mounting Method of SMD (Surface Mount Device) for Lead-free Solder

Mounting Condition

1. For soldering, Lead-free solder (Sn-3.0Ag-0.5Cu)*¹ or equivalent shall be used.
(*1: The figure displays with weight %. A predominantly tin-rich alloy with 3.0% silver and 0.5% copper.)
2. A rosin type flux with a chlorine content of 0.2% or less shall be used. The rosin flux with low halogen content is recommended.
3. When soldering, use one of the following time/ temperature methods for acceptable solder joints. Make sure the devices have been properly prepared with flux prior soldering.

* Reflow soldering method (Infrared reflow / Heat circulation reflow / Hot plate reflow):

Limit solder to 3 reflow cycles because resin is used in the modules manufacturing process. Excessive reflow cycles will effect the resin resulting in a potential failure or latent defect. The recommended reflow temperature profile is shown below. The temperature of the reflow profile must be measured at the device lead.

Reflow temperature profile and condition:

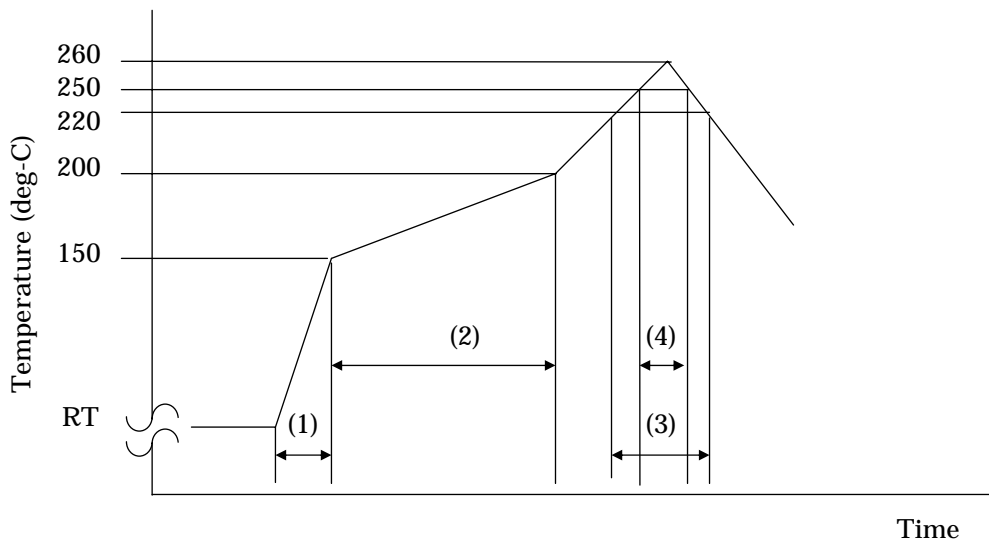

- | | | |
|---------------------------|------------------------------------|-----------------|
| (1) Average Ramp-up Rate: | 3deg-C/seconds | |
| (2) Preheating: | 150 - 200deg-C, | 60 - 180seconds |
| (3) Main heating: | 220deg-C, | 60seconds max. |
| (4) Peak Temperature: | 260deg-C max., more than 250deg-C, | 10 seconds max. |
- * Measurement point: Device lead.

4. The above-recommended conditions were confirmed using the manufacture's equipment and materials. However, when soldering these products, the soldering condition should be verified by customer using their equipment and materials.

FMM5059VU

Ku-Band Power Amplifier MMIC

For further information please contact :

Eudyna Devices USA Inc.

2355 Zanker Rd.
San Jose, CA 95131-1138, U.S.A.
TEL: +1 408 232-9500
FAX: +1 408 428-9111

Eudyna Devices Europe Ltd.

150 Edinburgh Avenue
Slough, Berkshire, SL1 4SS
United Kingdom
TEL: +44 (0) 1753 849950
FAX: +44 (0) 1753 577128

Eudyna Devices International Srl

Via Teglio 8/2 - 20158
Milano, Italy
TEL: +39-02-3705 2921
FAX: +39-02-3705 2920

Eudyna Devices Asia Pte. Ltd.

Hong Kong Branch
Suite 1906B, Tower 6, China Hong Kong City
33 Canton Road, Tsimshatsui, Kowloon
Hong Kong
TEL: +852-2377-0227
FAX: +852-2377-3921

Eudyna Devices Inc.

1000 Kamisukiahara, showa-cho
Nakakomagun, Yamanashi
409-3883, Japan
(Kokubo Industrial Park)
TEL +81-55-275-4411
FAX +81-55-275-9461

Sales Division

1, Kanai-cho, Sakae-ku
Yokohama, 244-0845, Japan
TEL +81-45-853-8156
FAX +81-45-853-8170

CAUTION

Eudyna Devices Inc. products contain **gallium arsenide (GaAs)** which can be hazardous to the human body and the environment. For safety, observe the following procedures:

- Do not put these products into the mouth.
- Do not alter the form of this product into a gas, powder, or liquid through burning, crushing, or chemical processing as these by-products are dangerous to the human body if inhaled, ingested, or swallowed.
- Observe government laws and company regulations when discarding this product. This product must be discarded in accordance with methods specified by applicable hazardous waste procedures.

Eudyna Devices Inc. reserves the right to change products and specifications without notice. The information does not convey any license under rights of Eudyna Devices Inc. or others.

© 2008 Eudyna Devices Inc.