

FEATURES

- High Output Power: $P_{1dB} = 36.5\text{dBm}$ (Typ.)
- High Gain: $G_{1dB} = 11.0\text{dB}$ (Typ.)
- High PAE: $\eta_{add} = 37\%$ (Typ.)
- Low IM3 = $-46\text{dBc}@P_o = 25.5\text{dBm}$
- Broad Band: 4.4 to 5.0GHz
- Impedance Matched $Z_{in}/Z_{out} = 50\text{ohm}$
- Hermetically Sealed Package

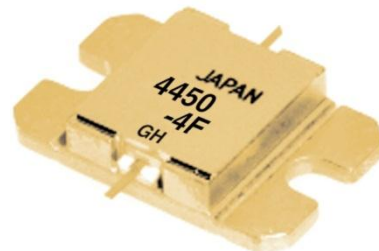

DESCRIPTION

The FLM4450-4F is a power GaAs FET that is internally matched for standard communication bands to provide optimum power and gain in a 50 ohm system.

SEDI's stringent Quality Assurance Program assures the highest reliability and consistent performance.

ABSOLUTE MAXIMUM RATING (Ambient Temperature $T_a=25\text{deg.C}$)

Item	Symbol	Condition	Rating	Unit
Drain-Source Voltage	V_{DS}		15	V
Gate-Source Voltage	V_{GS}		-5	V
Total Power Dissipation	P_T	$T_c = 25\text{deg.C}$	25.0	W
Storage Temperature	T_{stg}		-65 to +175	deg.C
Channel Temperature	T_{ch}		175	deg.C

SEDI recommends the following conditions for the reliable operation of GaAs FETs:

1. The drain-source operating voltage (V_{DS}) should not exceed 10 volts.
2. The forward and reverse gate currents should not exceed 16.0 and -2.2 mA respectively with gate resistance of 100ohm.

ELECTRICAL CHARACTERISTICS (Ambient Temperature $T_a=25\text{deg.C}$)

Item	Symbol	Test Conditions	Limit			Unit
			Min.	Typ.	Max.	
Saturated Drain Current	I_{DSS}	$V_{DS}=5V, V_{GS}=0V$	-	1950	2900	mA
Transconductance	g_m	$V_{DS}=5V, I_{DS}=1100\text{mA}$	-	1000	-	mS
Pinch-off Voltage	V_p	$V_{DS}=5V, I_{DS}=90\text{mA}$	-1.0	-2.0	-3.5	V
Gate Source Breakdown Voltage	V_{GSO}	$I_{GS}=-90\mu\text{A}$	-5.0	-	-	V
Output Power at 1dB G.C.P.	P_{1dB}	$V_{DS}=10V,$	35.5	36.5	-	dBm
Power Gain at 1dB G.C.P.	G_{1dB}	$I_{DS}=0.55 I_{DSS}$ (Typ.),	10.0	11.0	-	dB
Drain Current	I_{dsr}	$f=4.4$ to 5.0 GHz,	-	1100	1300	mA
Power-added Efficiency	η_{add}	$Z_S=Z_L=50\text{ohm}$	-	37	-	%
Gain Flatness	ΔG		-	-	± 0.6	dB
3rd Order Intermodulation Distortion	IM_3	$f = 5.0$ GHz, $\Delta f = 10$ MHz 2-Tone Test $P_{out} = 25.5\text{dBm}$ S.C.L.	-44	-46	-	dBc
Thermal Resistance	R_{th}	Channel to Case	-	5.0	6.0	deg.C/W
Channel Temperature Rise	ΔT_{ch}	$10V \times I_{dsr} \times R_{th}$	-	-	80	deg.C

G.C.P.: Gain Compression Point, S.C.L.: Single Carrier Level

CASE STYLE	IB	
ESD	Class 3A	4000V to 8000V
Note : Based on EIAJ ED-4701 C-111A (C=100pF, R=1.5kohm)		
RoHS Compliance	Yes	

POWER DERATING CURVE

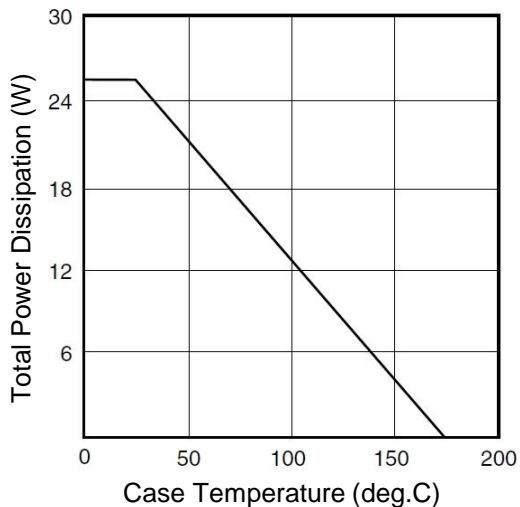

OUTPUT POWER & IM₃ vs. INPUT POWER

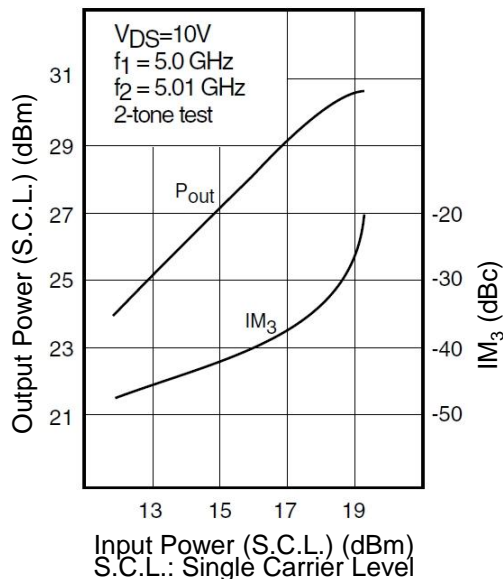

OUTPUT POWER vs. FREQUENCY

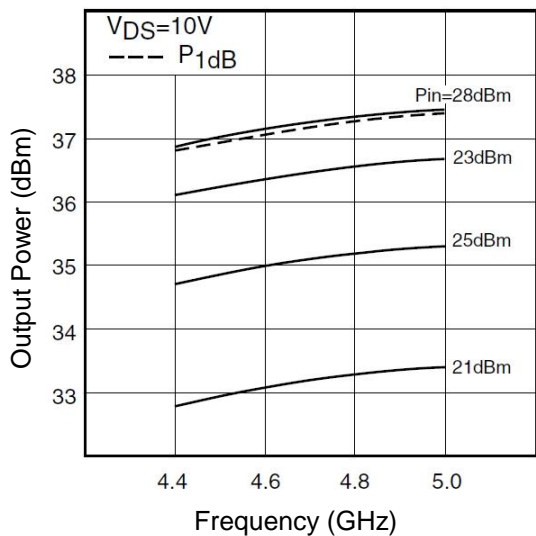

OUTPUT POWER vs. INPUT POWER

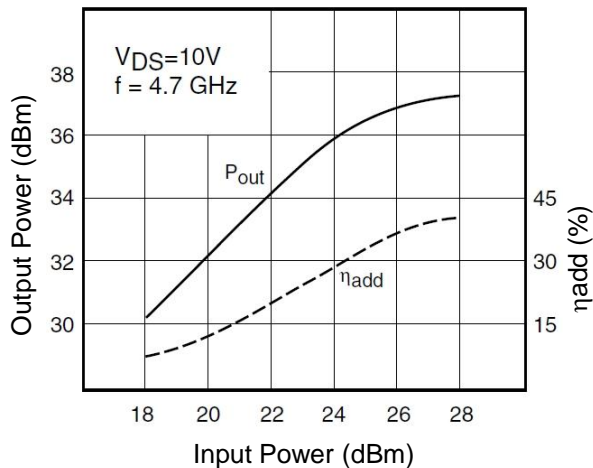

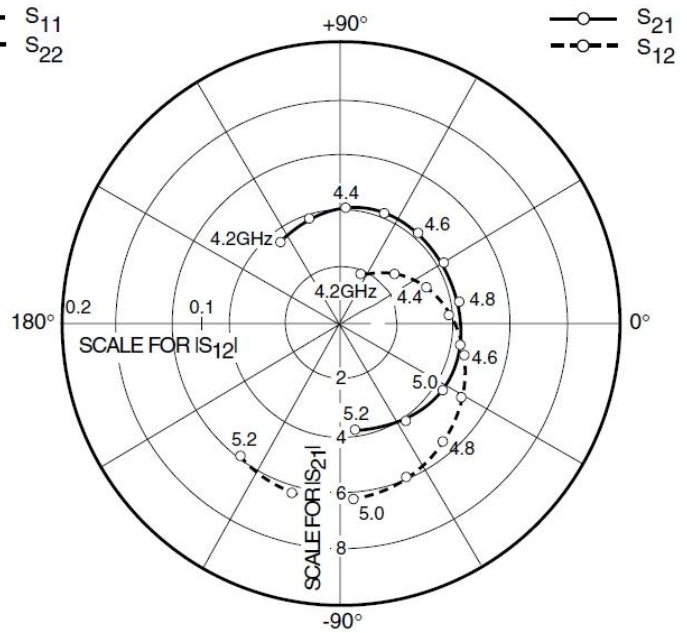
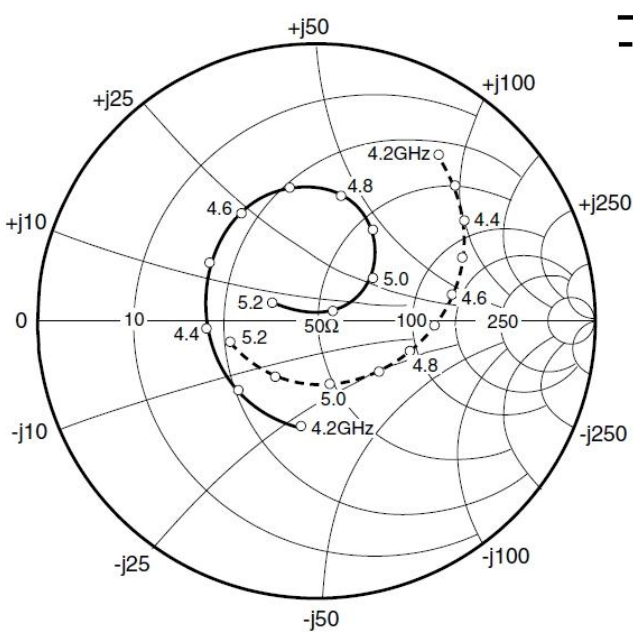

S-PARAMETERS

$V_{DS} = 10V, I_{DS} = 1100mA$

FREQUENCY (MHz)	S11		S21		S12		S22	
	MAG	ANG	MAG	ANG	MAG	ANG	MAG	ANG
4200	0.388	-98.6	3.672	126.7	0.039	62.7	0.740	53.8
4300	0.373	-139.1	3.921	107.5	0.052	42.8	0.700	44.0
4400	0.397	-176.6	4.081	87.9	0.066	22.9	0.640	34.1
4500	0.443	151.5	4.166	68.3	0.078	3.8	0.565	23.3
4600	0.471	124.2	4.220	49.0	0.090	-14.3	0.487	11.3
4700	0.487	100.8	4.250	29.8	0.100	-31.6	0.422	-2.2
4800	0.455	78.6	4.290	10.1	0.111	-49.2	0.354	-18.7
4900	0.385	57.7	4.318	-10.7	0.118	-66.9	0.284	-41.1
5000	0.256	36.6	4.308	-32.9	0.125	-85.9	0.236	-77.7
5100	0.066	29.7	4.173	-57.2	0.125	-106.4	0.253	-124.7
5200	0.170	156.7	3.828	-82.7	0.118	-128.0	0.317	-165.0

Case Style "IB"
Metal-Ceramic Hermetic Package

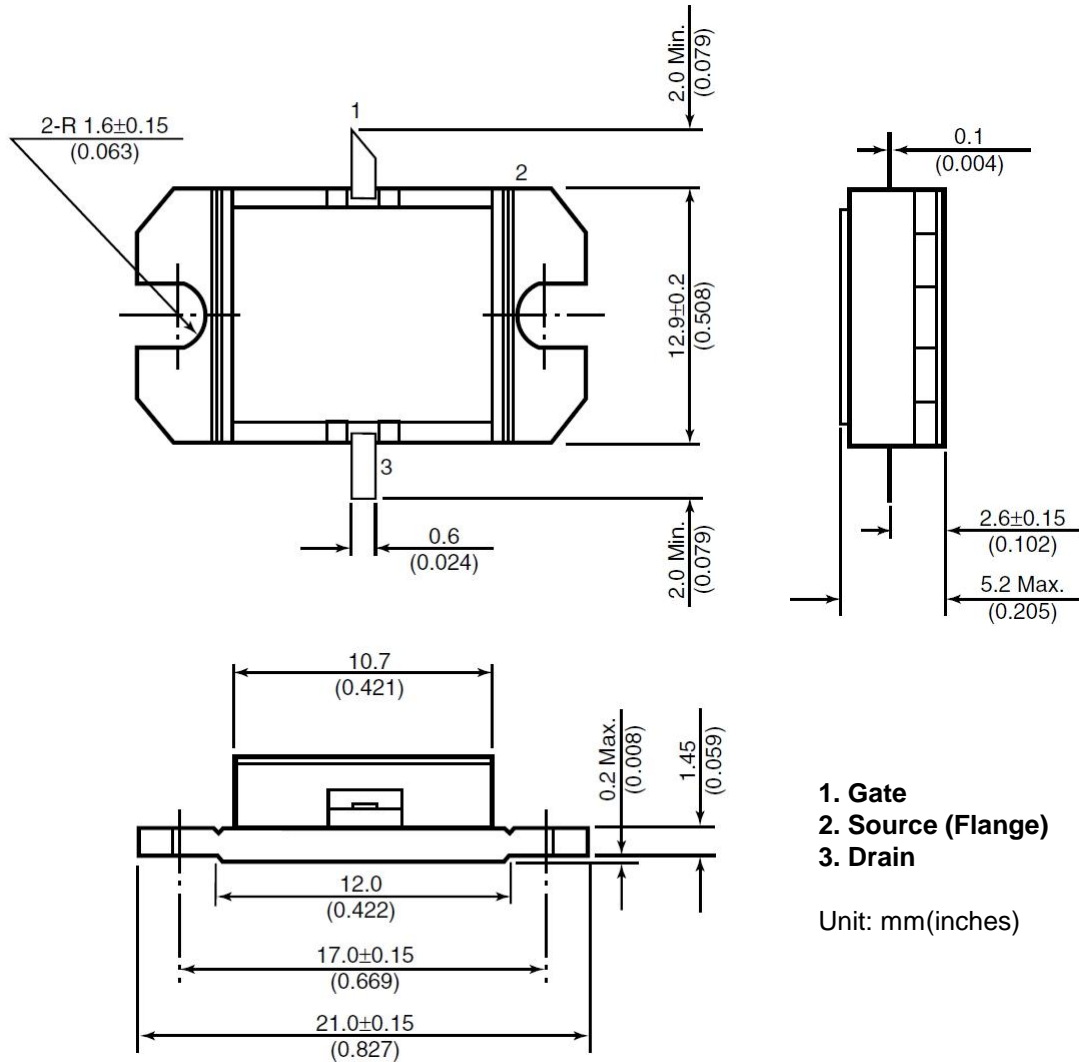



FLM4450-4F

C-Band Internally Matched FET

For further information please contact:

<http://global-sei.com/Electro-optic/about/office.html>

CAUTION

This product contains **gallium arsenide (GaAs)** which can be hazardous to the human body and the environment. For safety, observe the following procedures:

- Do not put these products into the mouth.
- Do not alter the form of this product into a gas, powder, or liquid through burning, crushing, or chemical processing as these by-products are dangerous to the human body if inhaled, ingested, or swallowed.
- Observe government laws and company regulations when discarding this product. This product must be discarded in accordance with methods specified by applicable hazardous waste procedures.