

FEATURES

- High Output Power: $P_{1dB} = 36.5\text{dBm}$ (Typ.)
- High Gain: $G_{1dB} = 12.0\text{dB}$ (Typ.)
- High PAE: $\eta_{add} = 38\%$ (Typ.)
- Low IM3 = $-46\text{dBc}@P_o = 25.5\text{dBm}$
- Broad Band: 3.7 to 4.2GHz
- Impedance Matched $Z_{in}/Z_{out} = 50\text{ohm}$
- Hermetically Sealed Package

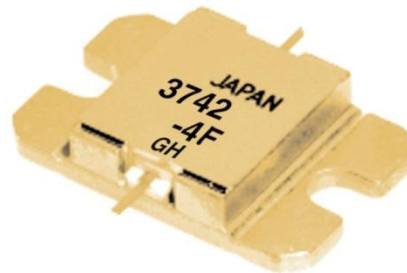

DESCRIPTION

The FLM3742-4F is a power GaAs FET that is internally matched for standard communication bands to provide optimum power and gain in a 50 ohm system.

SEDI's stringent Quality Assurance Program assures the highest reliability and consistent performance.

ABSOLUTE MAXIMUM RATING (Ambient Temperature $T_a=25\text{deg.C}$)

Item	Symbol	Condition	Rating	Unit
Drain-Source Voltage	V_{DS}		15	V
Gate-Source Voltage	V_{GS}		-5	V
Total Power Dissipation	P_T	$T_c = 25\text{deg.C}$	25	W
Storage Temperature	T_{stg}		-65 to +175	deg.C
Channel Temperature	T_{ch}		175	deg.C

SEDI recommends the following conditions for the reliable operation of GaAs FETs:

1. The drain-source operating voltage (V_{DS}) should not exceed 10 volts.
2. The forward and reverse gate currents should not exceed 16.0 and -2.2 mA respectively with gate resistance of 100ohm.

ELECTRICAL CHARACTERISTICS (Ambient Temperature $T_a=25\text{deg.C}$)

Item	Symbol	Test Conditions	Limit			Unit
			Min.	Typ.	Max.	
Saturated Drain Current	I_{DSS}	$V_{DS}=5V, V_{GS}=0V$	-	1950	2900	mA
Transconductance	g_m	$V_{DS}=5V, I_{DS}=1100\text{mA}$	-	1000	-	mS
Pinch-off Voltage	V_p	$V_{DS}=5V, I_{DS}=90\text{mA}$	-1.0	-2.0	-3.5	V
Gate Source Breakdown Voltage	V_{GSO}	$I_{GS}=-90\mu A$	-5.0	-	-	V
Output Power at 1dB G.C.P.	P_{1dB}	$V_{DS}=10V,$	35.5	36.5	-	dBm
Power Gain at 1dB G.C.P.	G_{1dB}	$I_{DS}=0.55 I_{DSS}$ (Typ.),	11.0	12.0	-	dB
Drain Current	I_{dsr}	$f=3.7$ to 4.2 GHz,	-	1100	1300	mA
Power-added Efficiency	η_{add}	$Z_S=Z_L=50\text{ohm}$	-	38	-	%
Gain Flatness	ΔG		-	-	± 0.6	dB
3rd Order Intermodulation Distortion	IM_3	$f = 4.2$ GHz, $\Delta f = 10$ MHz 2-Tone Test $P_{out} = 25.5\text{dBm}$ S.C.L.	-44	-46	-	dBc
Thermal Resistance	R_{th}	Channel to Case	-	5.0	6.0	deg.C/W
Channel Temperature Rise	ΔT_{ch}	$10V \times I_{dsr} \times R_{th}$	-	-	80	deg.C

G.C.P.: Gain Compression Point, S.C.L.: Single Carrier Level

CASE STYLE	IB	
ESD	Class 3A	4000V to 8000V
Note : Based on EIAJ ED-4701 C-111A (C=100pF, R=1.5kohm)		
RoHS Compliance	Yes	

POWER DERATING CURVE

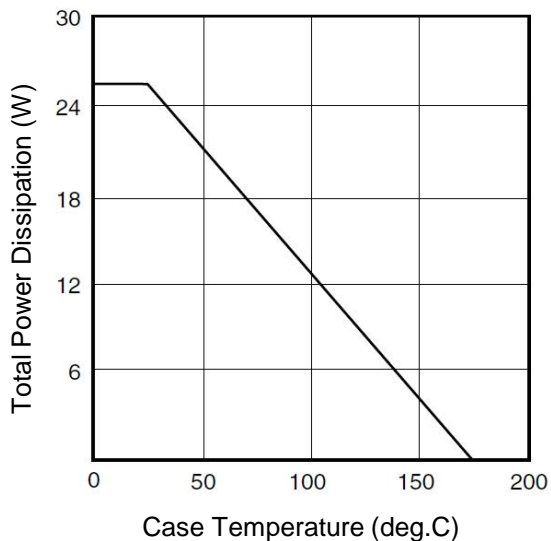

OUTPUT POWER & IM₃ vs. INPUT POWER

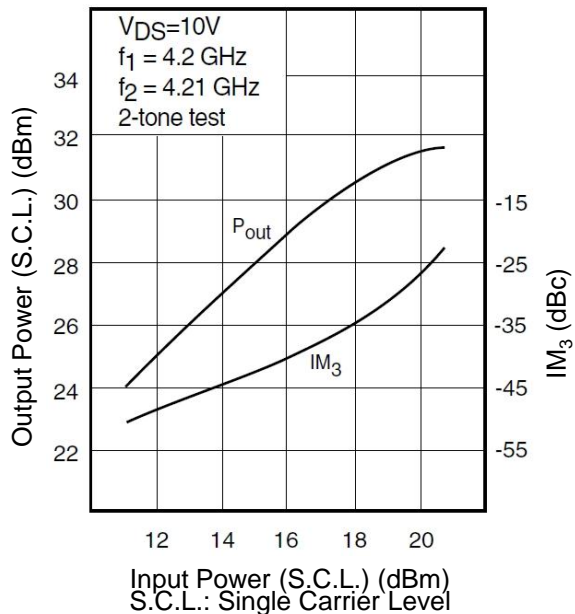

OUTPUT POWER vs. FREQUENCY

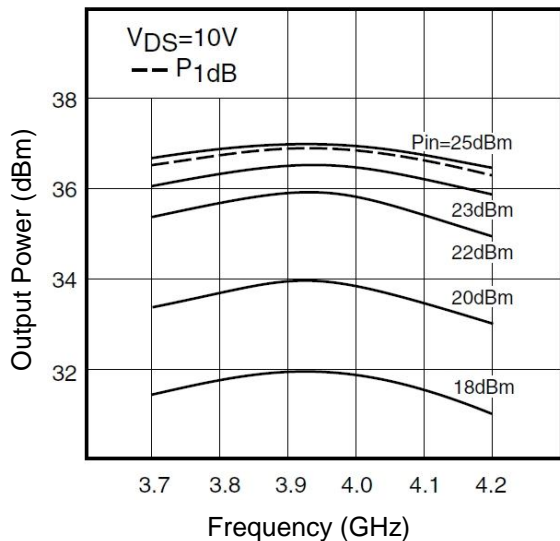

OUTPUT POWER vs. INPUT POWER

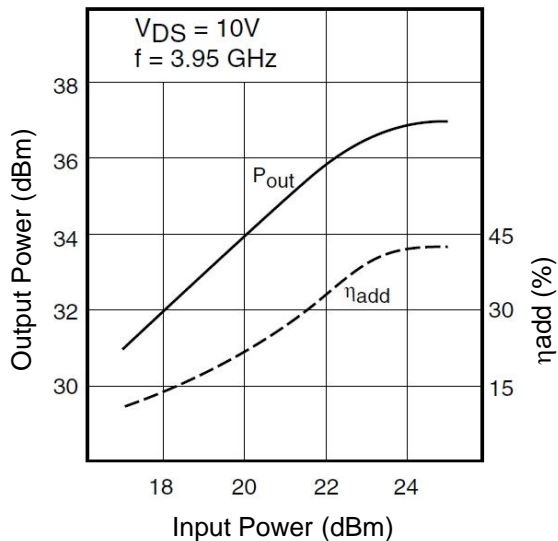

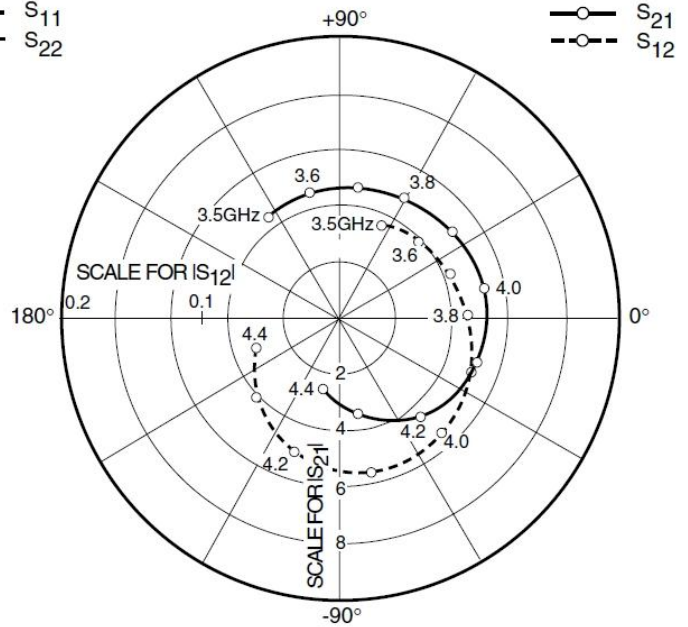
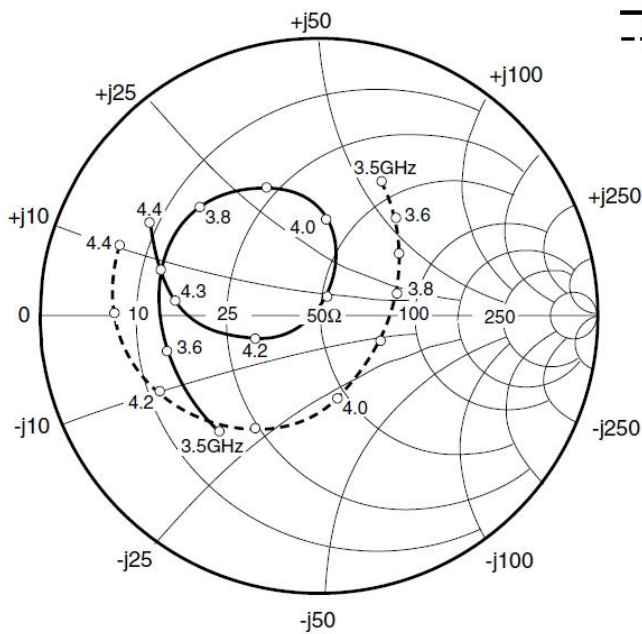

S-PARAMETERS

$V_{DS} = 10V, I_{DS} = 1100mA$

FREQUENCY (MHz)	S11		S21		S12		S22	
	MAG	ANG	MAG	ANG	MAG	ANG	MAG	ANG
3500	0.544	-131.8	4.422	126.1	0.072	66.8	0.525	65.0
3600	0.565	-167.2	4.582	104.0	0.079	44.5	0.445	53.3
3700	0.592	163.0	4.706	82.3	0.084	21.8	0.359	38.8
3800	0.578	137.2	4.824	60.9	0.092	0.5	0.287	15.8
3900	0.503	112.5	4.999	37.4	0.101	-22.7	0.245	-23.6
4000	0.354	86.5	5.190	11.5	0.109	-48.7	0.306	-76.9
4100	0.079	69.5	5.088	-18.7	0.111	-78.8	0.468	-119.9
4200	0.248	-160.8	4.476	-51.1	0.102	-109.3	0.634	-154.3
4300	0.526	173.3	3.516	-80.5	0.082	-137.0	0.730	179.6
4400	0.698	151.1	2.594	-104.6	0.064	-160.3	0.757	160.6

Case Style "IB"
Metal-Ceramic Hermetic Package

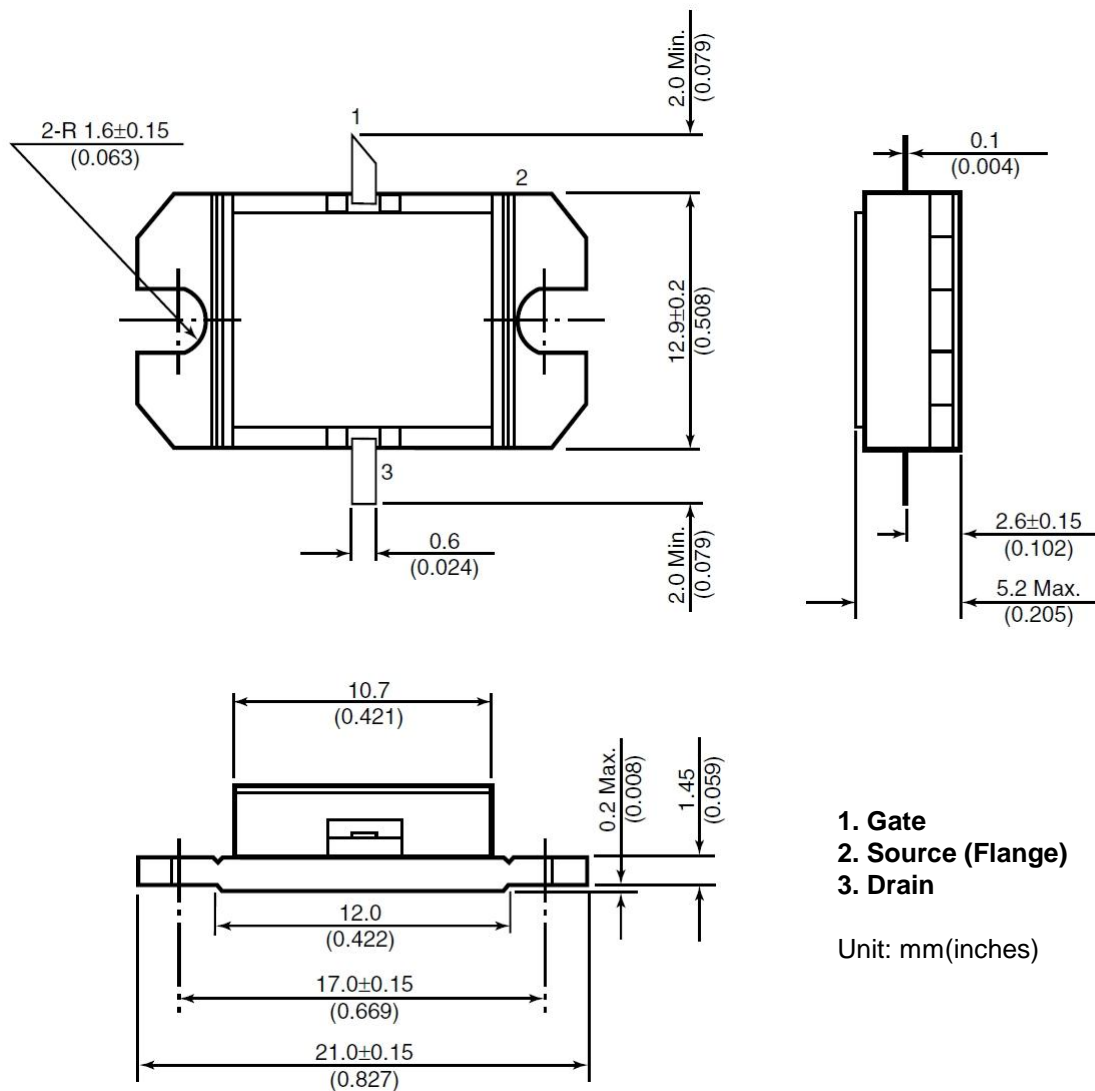

For further information please contact:

<http://global-sei.com/Electro-optic/about/office.html>

CAUTION

This product contains **gallium arsenide (GaAs)** which can be hazardous to the human body and the environment. For safety, observe the following procedures:

- Do not put these products into the mouth.
- Do not alter the form of this product into a gas, powder, or liquid through burning, crushing, or chemical processing as these by-products are dangerous to the human body if inhaled, ingested, or swallowed.
- Observe government laws and company regulations when discarding this product. This product must be discarded in accordance with methods specified by applicable hazardous waste procedures.