

● FEATURES

High Output Power: P1dB=36.0dBm (Typ.)
 High Gain: G1dB=10.5dB (Typ.)
 High PAE: η_{add} =35% (Typ.)
 Broad Band: 7.1~7.9GHz
 Internally matched
 Plastic Package for SMT applications

● DESCRIPTION

The ELM7179-4PS is a power GaAs FET that is internally matched for standard communication bands to provide optimum power and gain.

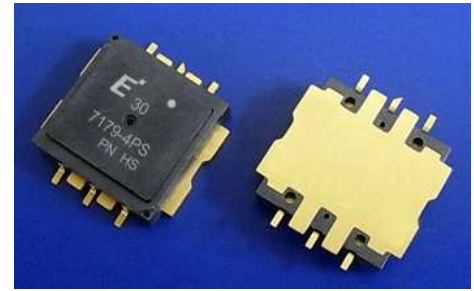

ABSOLUTE MAXIMUM RATING (Case Temperature Tc=25 deg-C)

Item	Symbol	Rating	Unit
Drain-Source Voltage	V_{DS}	15	V
Gate-Source Voltage	V_{GS}	-5	V
Total Power Dissipation	P_T	27.3	W
Storage Temperature	T_{STG}	-40 to +125	deg-C
Channel Temperature	T_{CH}	175	deg-C

RECOMMENDED OPERATING CONDITION (Case Temperature Tc=25 deg-C)

Item	Symbol	Condition	Limit	Unit
DC Input Voltage	V_{DS}		<10	V
Forward Gate Current	I_{GF}	$R_G=100$ ohm	<+16	mA
Reverse Gate Current	I_{GR}	$R_G=100$ ohm	>-2.2	mA
Channel Temperature	T_{CH}		155	deg-C

ELECTRICAL CHARACTERISTICS (Case Temperature Tc=25 deg-C)

Item	Symbol	Condition	Limit			Unit
			Min.	Typ.	Max.	
Drain Current	I_{DSS}	$V_{DS}=5V, V_{GS}=0V$	-	1700	2600	mA
Trans conductance	gm	$V_{DS}=5V, I_{DS}=1100mA$	-	1700	-	mS
Pinch-off Voltage	V_P	$V_{DS}=5V, I_{DS}=85mA$	-0.5	-1.5	-3.0	V
Gate-Source Breakdown Voltage	V_{GSO}	$I_{GS}=85uA$	-5.0	-	-	V
Output Power at 1dB G.C.P.	P_{1dB}	$V_{DS}=10V$ $I_{DS(DC)}=0.65I_{DSS}(typ.)$ $f=7.1\sim 7.9$ GHz	35.0	36.0	-	dBm
Power Gain at 1dB G.C.P.	G_{1dB}		9.0	10.5	-	dB
Drain Current	I_{dsr}		-	1100	1300	mA
Power Added Efficiency	η_{add}		-	35	-	%
Gain Flatness	ΔG		-	-	1.2	dB
3 rd Order Inter Modulation Distortion	IM_3		$f=7.9GHz$ $\Delta f=10MHz, 2\text{-tone Test}$ $P_{out}=25.5dBm$ (S.C.L)	-40	-43	-
R_{th}	R_{th}	Channel to Case	-	4.5	5.5	Deg-C/W
ΔT_{ch}	ΔT_{ch}	$10V \times I_{dsr} \times R_{th}$	-	-	71.5	Deg-C

ELM7179-4PS

C-Band Internally Matched FET



CASE STYLE: I2C

ESD	Class 3 A	4000-8000V
MSL	2A	4 weeks after open the package

Ordering Information

Model Type	MOQ	MOU	Packing Style
ELM7179-4PS	15pcs	15pcs	15pcs Tray
ELM7179-4PST	500pcs	500pcs	24mm width Tape (500pcs/Reel)

*MOQ stands for Minimum Order Quantity.

*MOU stands for Minimum Order Unit size.

Note

- This device will not be delivered with test data but tested pass/fail 100% against DC and RF specifications.
- NO liquid cleaning process is suitable for this device. (including de-ionized water or solvent)

- RF Characteristics

Power Derating Curve

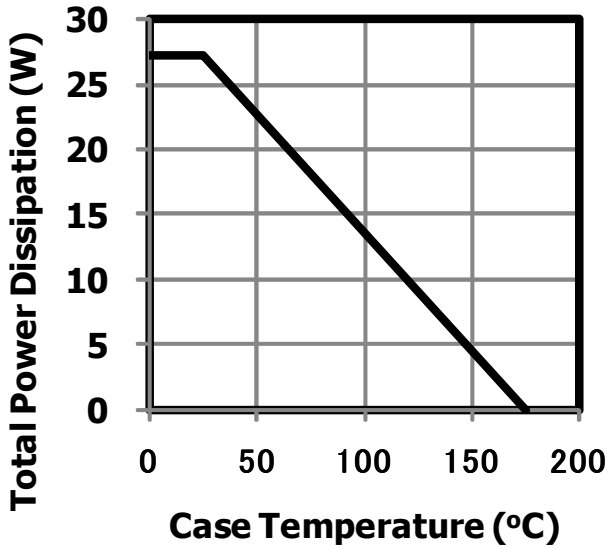

Input Power vs. Output Power, Power Added Efficiency

$V_{DS}=10V, I_{DS(DC)}=1100mA$

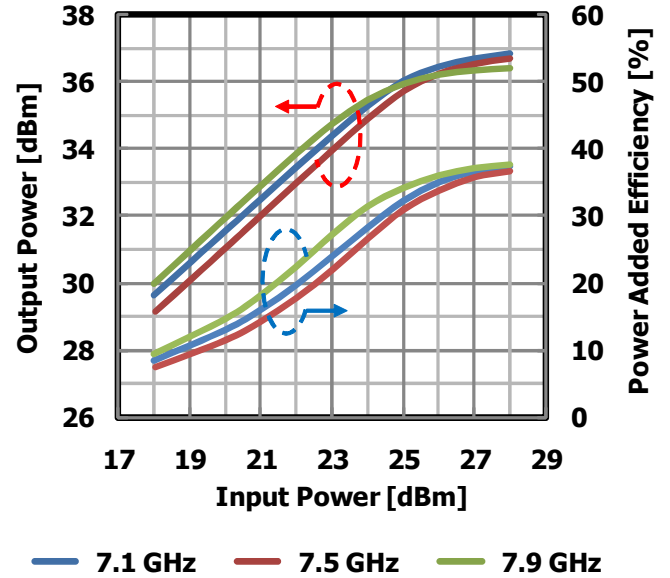

Output Power vs. Frequency

$V_{DS}=10V, I_{DS(DC)}=1100mA$

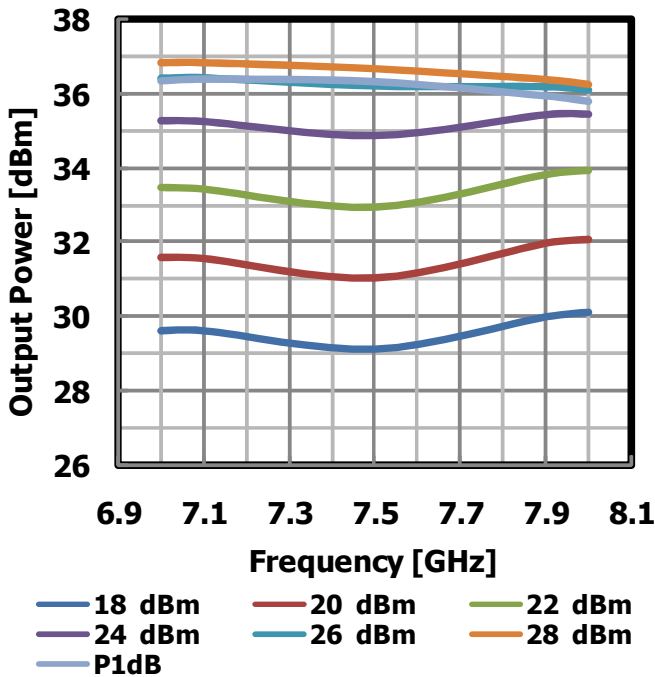

IMD vs. Output Power

$V_{DS}=10V, I_{DS(DC)}=1100mA$

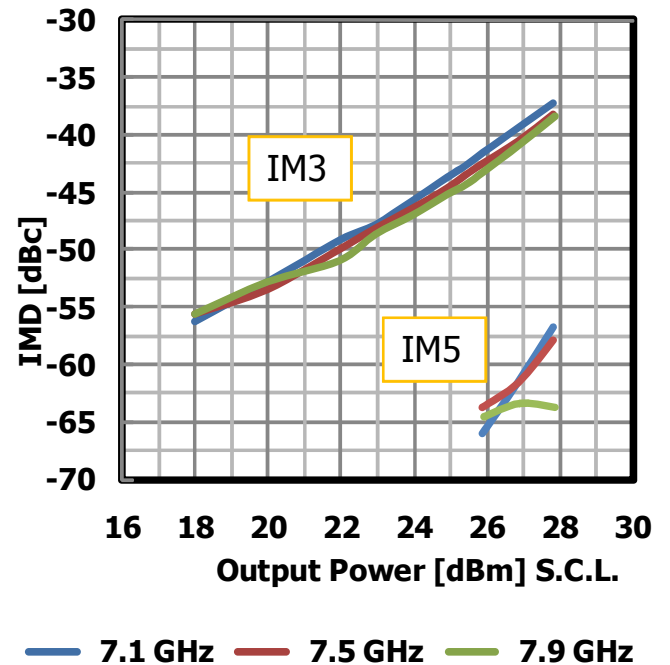

ELM7179-4PS

C-Band Internally Matched FET

Input Power vs. Output Power, Power Added Efficiency by Drain Voltage
 $I_{DS(DC)} = 1100\text{mA}$ @7.1GHz

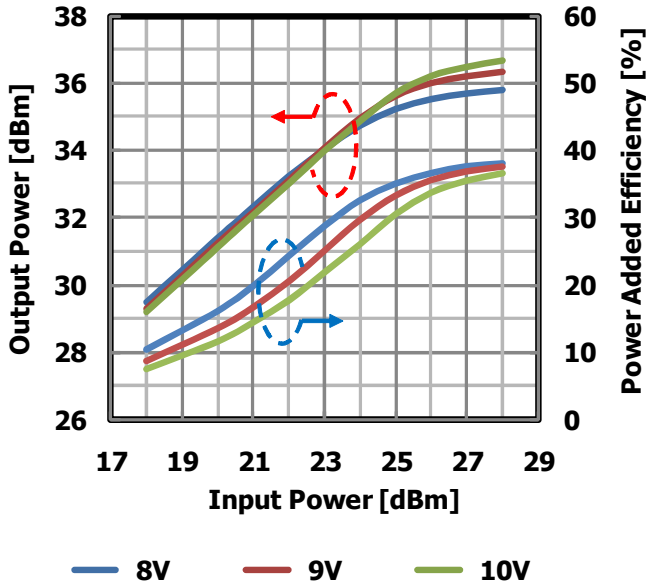

Input Power vs. Output Power, Power Added Efficiency by Drain Voltage
 $I_{DS(DC)} = 1100\text{mA}$ @7.5GHz

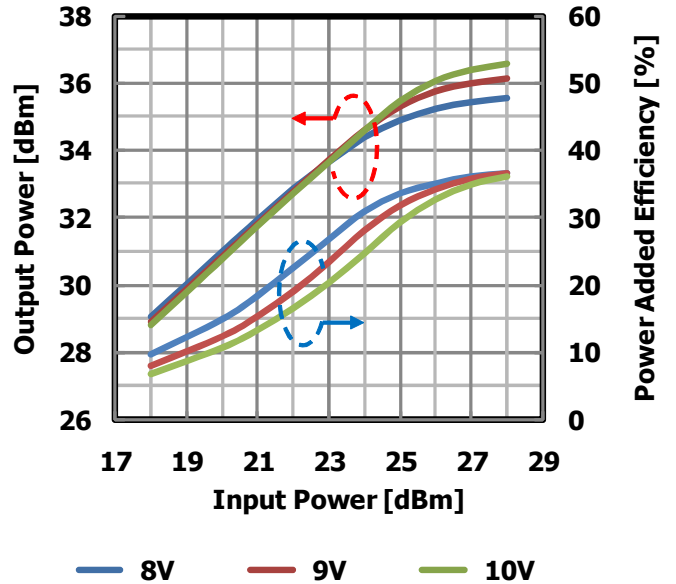

Input Power vs. Output Power, Power Added Efficiency by Drain Voltage
 $I_{DS(DC)} = 1100\text{mA}$ @7.9GHz

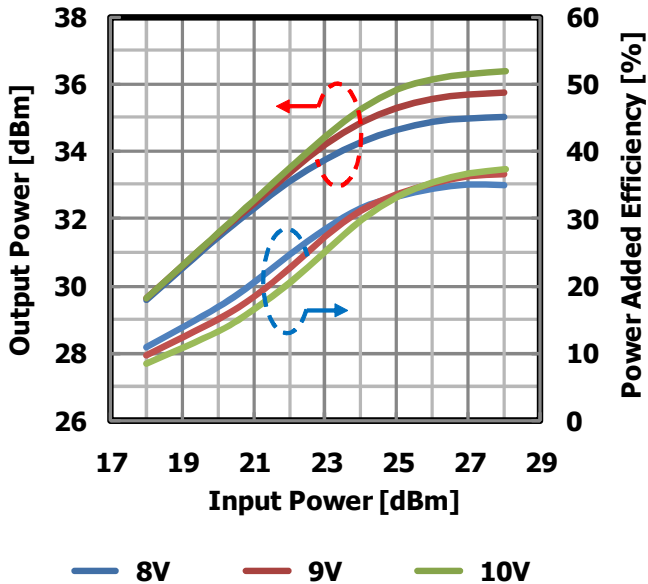

Input Power vs. Output Power, Power Added Efficiency by Quiescent Drain Current
 $V_{DS}=10V$ @7.1GHz

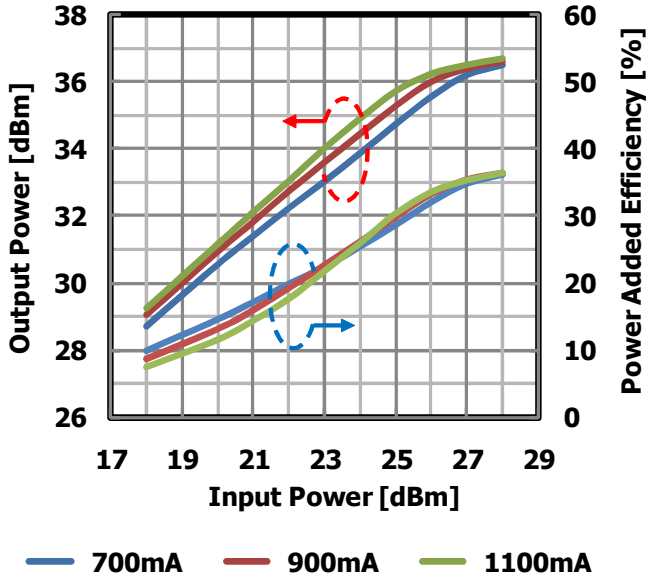

Input Power vs. Output Power, Power Added Efficiency by Quiescent Drain Current
 $V_{DS}=10V$ @7.5GHz

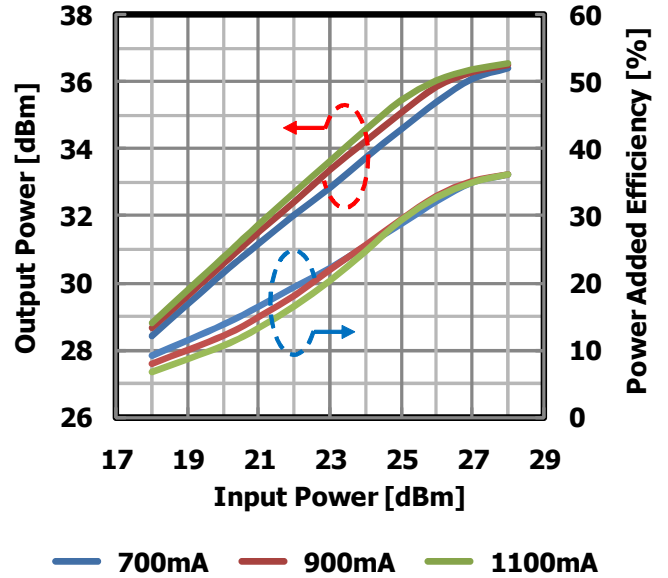

Input Power vs. Output Power, Power Added Efficiency by Quiescent Drain Current
 $V_{DS}=10V$ @7.9GHz

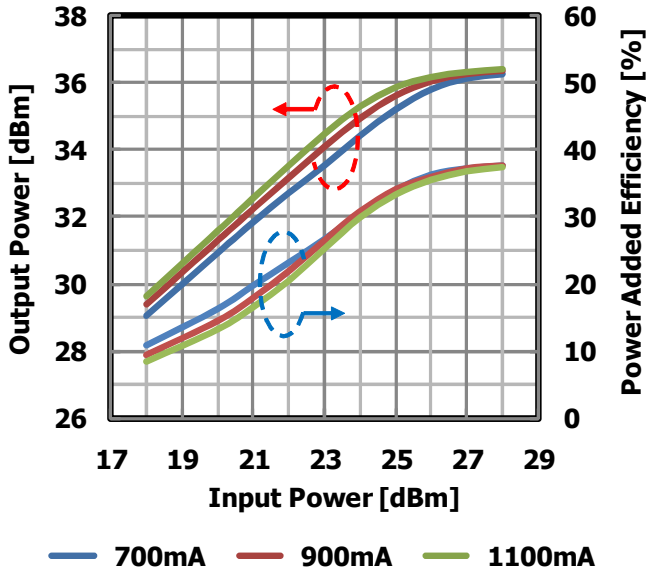

ELM7179-4PS

C-Band Internally Matched FET

Input Power vs. Output Power, Power Added Efficiency by Temperature
 $V_{DS}=10V$ @7.1GHz

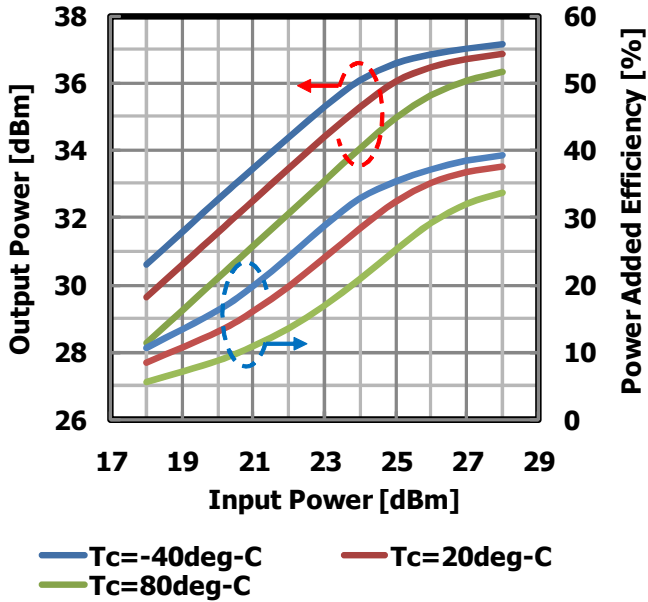

Input Power vs. Output Power, Power Added Efficiency by Temperature
 $V_{DS}=10V$ @7.5GHz

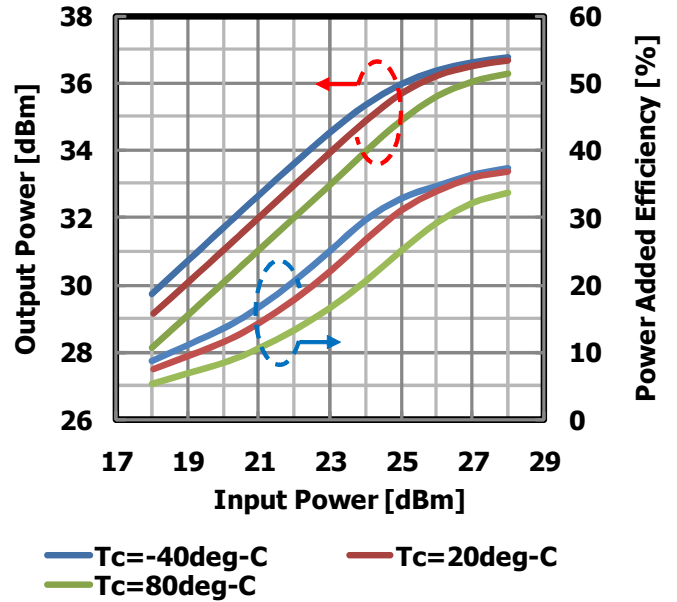

Input Power vs. Output Power, Power Added Efficiency by Temperature
 $V_{DS}=10V$ @7.9GHz

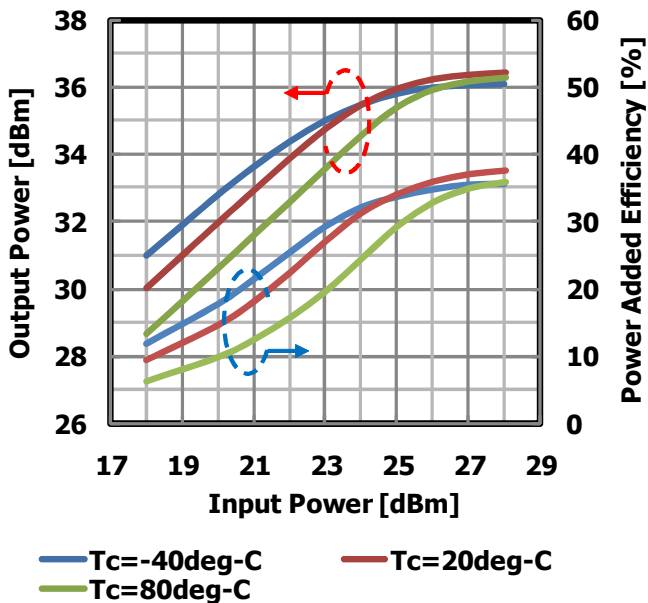

IMD Performance vs. Output Power by Drain Voltage

$I_{DS(DC)} = 1100\text{mA}$ @7.1GHz

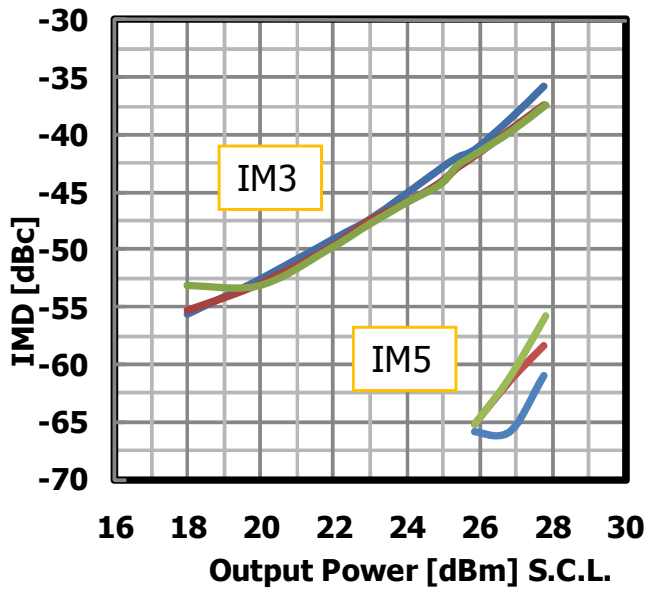

— 8V — 9V — 10V

IMD Performance vs. Output Power by Drain Voltage

$I_{DS(DC)} = 1100\text{mA}$ @7.5GHz

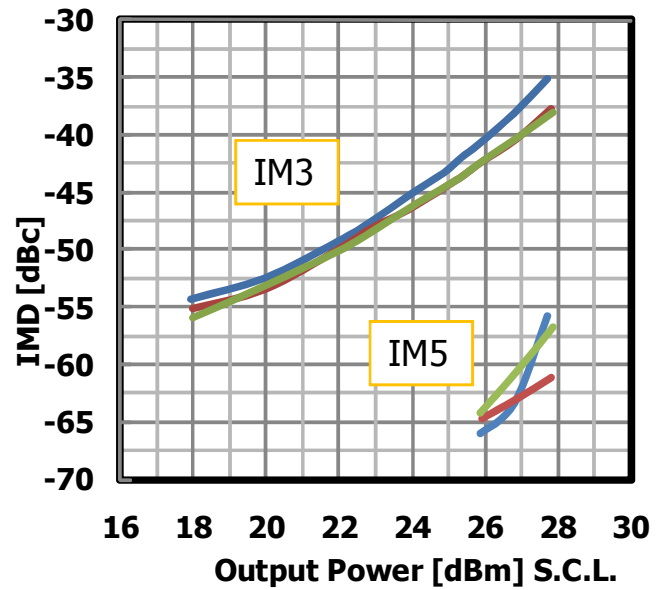

— 8V — 9V — 10V

IMD Performance vs. Output Power by Drain Voltage

$I_{DS(DC)} = 1100\text{mA}$ @7.9GHz

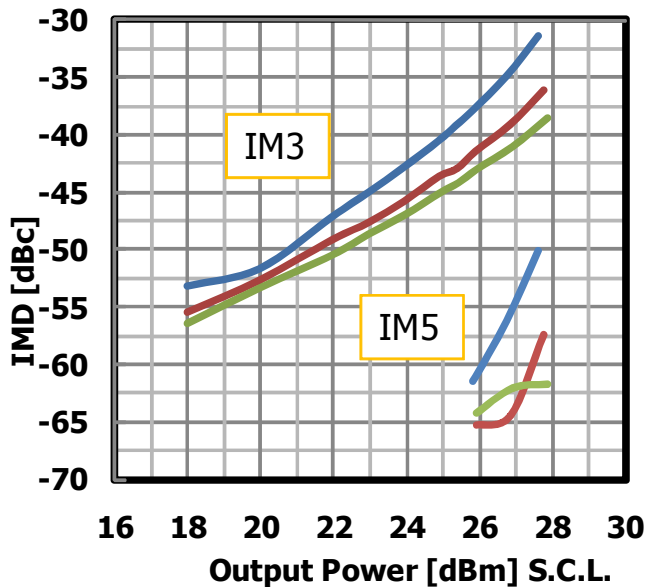

— 8V — 9V — 10V

ELM7179-4PS

C-Band Internally Matched FET

IMD Performance vs. Output Power by Quiescent Drain Current
 $V_{DS}=10V$ @7.1GHz

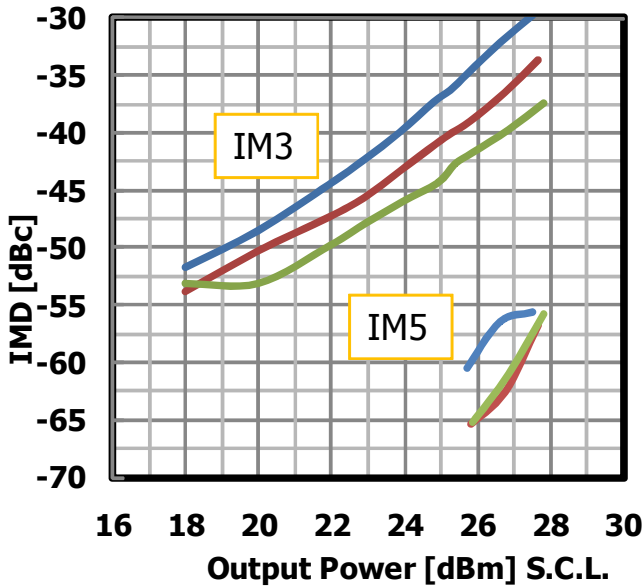

— 700mA — 900mA — 1100mA

IMD Performance vs. Output Power by Quiescent Drain Current
 $V_{DS}=10V$ @7.5GHz

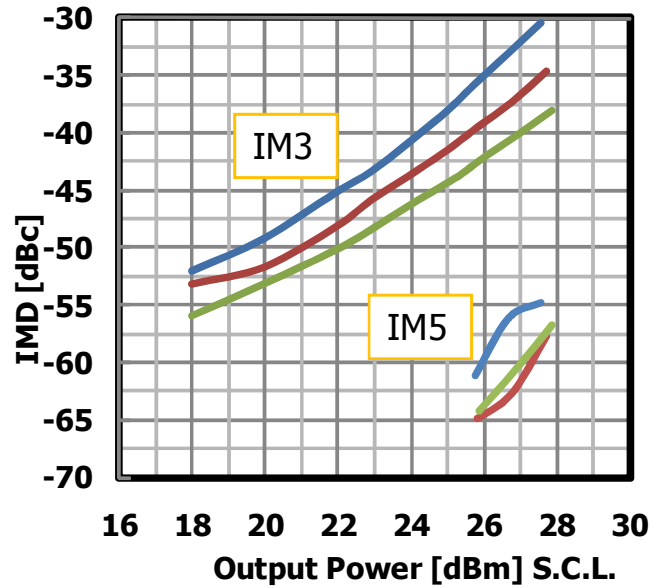

— 700mA — 900mA — 1100mA

IMD Performance vs. Output Power by Quiescent Drain Current
 $V_{DS}=10V$ @7.9GHz

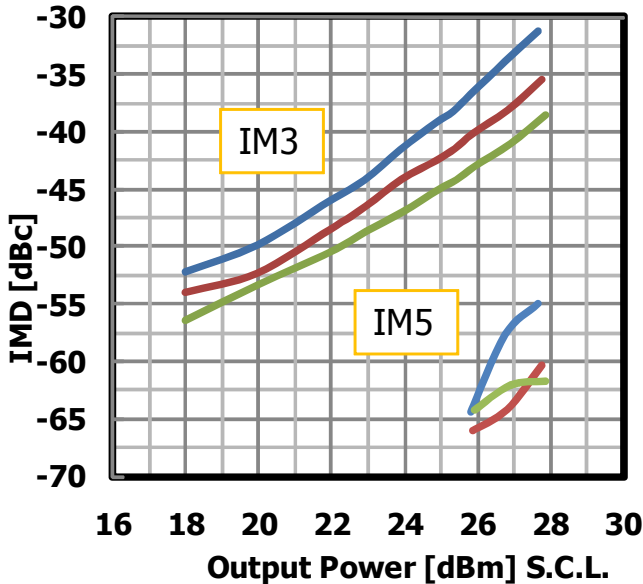

— 700mA — 900mA — 1100mA

IMD Performance vs. Output Power by Temperature
VDS=10V @7.1GHz

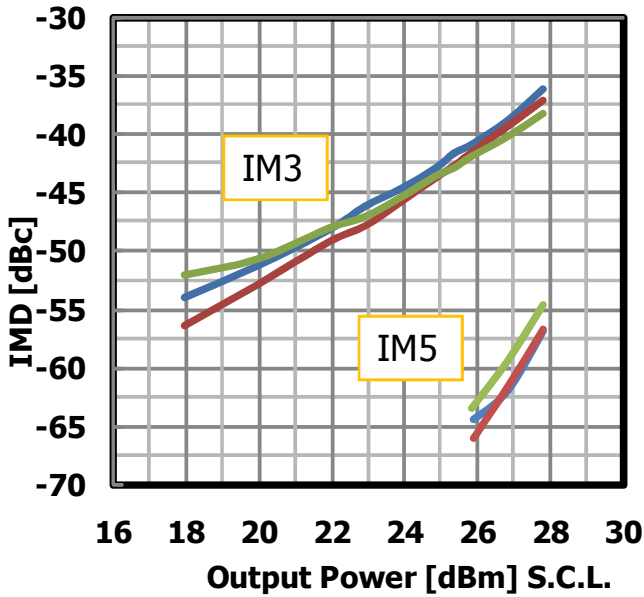

— Tc=-40deg-C — Tc=20deg-C
 — Tc=80deg-C

IMD Performance vs. Output Power by Temperature
VDS=10V @7.5GHz

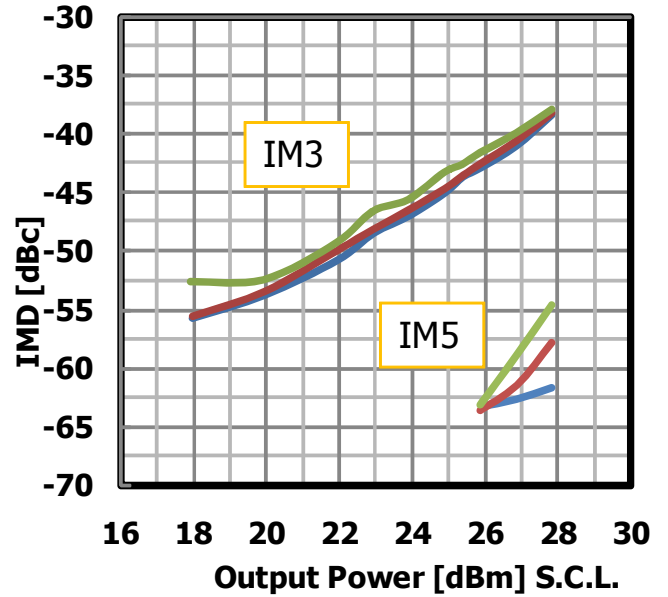

— Tc=-40deg-C — Tc=20deg-C
 — Tc=80deg-C

IMD Performance vs. Output Power by Temperature
VDS=10V @7.9GHz

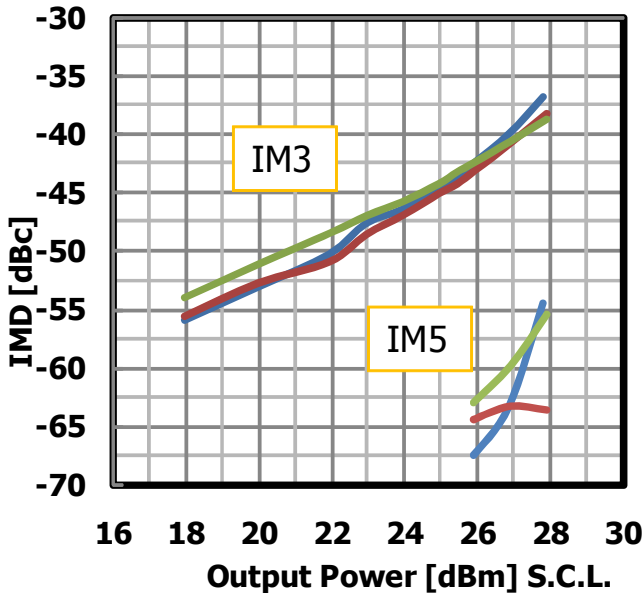

— Tc=-40deg-C — Tc=20deg-C
 — Tc=80deg-C

ELM7179-4PS

C-Band Internally Matched FET

● S-Parameter

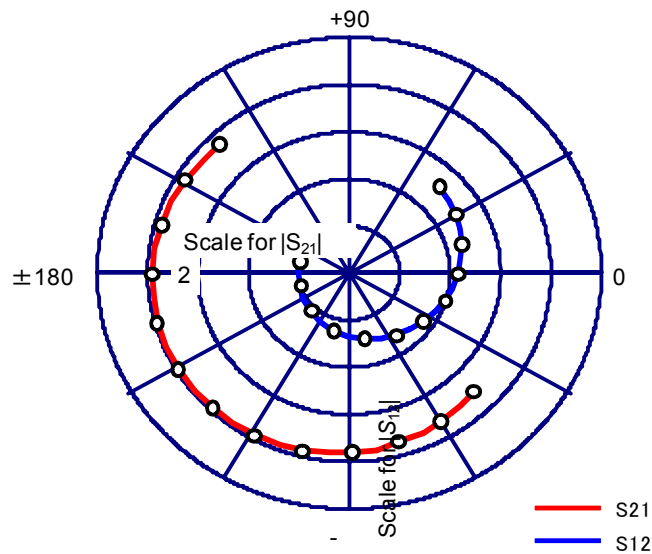
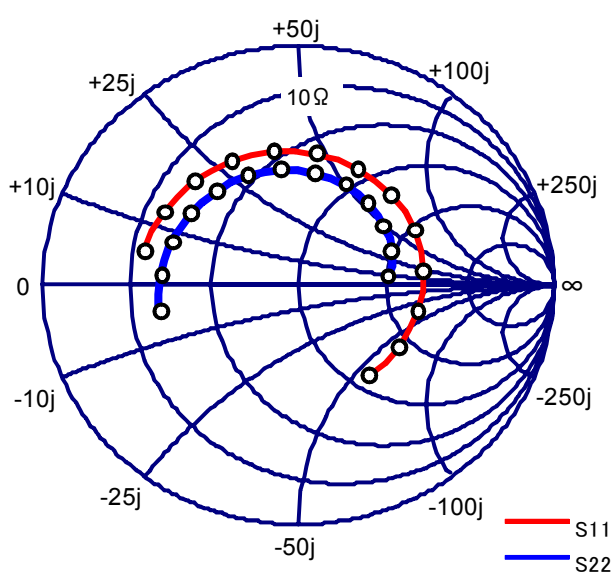

Frequency (MHz)	S11		S21		S12		S22	
	MAG	ANG	MAG	ANG	MAG	ANG	MAG	ANG
6900	0.689	173.1	3.012	-36.9	0.043	54.0	0.593	-168.4
7000	0.678	162.1	3.041	-49.1	0.040	41.5	0.592	179.9
7100	0.662	151.1	3.081	-60.8	0.038	29.3	0.597	169.4
7200	0.644	140.3	3.176	-72.3	0.035	16.3	0.597	159.5
7300	0.621	129.4	3.316	-84.2	0.033	2.5	0.596	150.1
7400	0.589	117.5	3.448	-96.5	0.030	-13.4	0.589	140.3
7500	0.552	104.0	3.614	-109.7	0.028	-31.1	0.575	130.7
7600	0.506	87.9	3.820	-123.9	0.027	-53.2	0.553	120.0
7700	0.450	68.4	4.038	-139.0	0.025	-80.7	0.519	108.4
7800	0.389	43.5	4.204	-155.2	0.023	-112.7	0.466	96.6
7900	0.344	11.5	4.311	-173.0	0.022	-145.5	0.398	83.2
8000	0.341	-24.7	4.336	168.5	0.023	-177.0	0.314	67.5
8100	0.380	-58.8	4.212	149.9	0.026	152.6	0.217	50.4

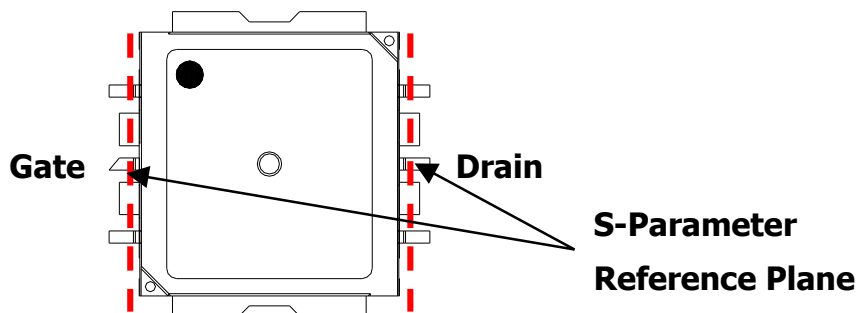

● **Package Outline**

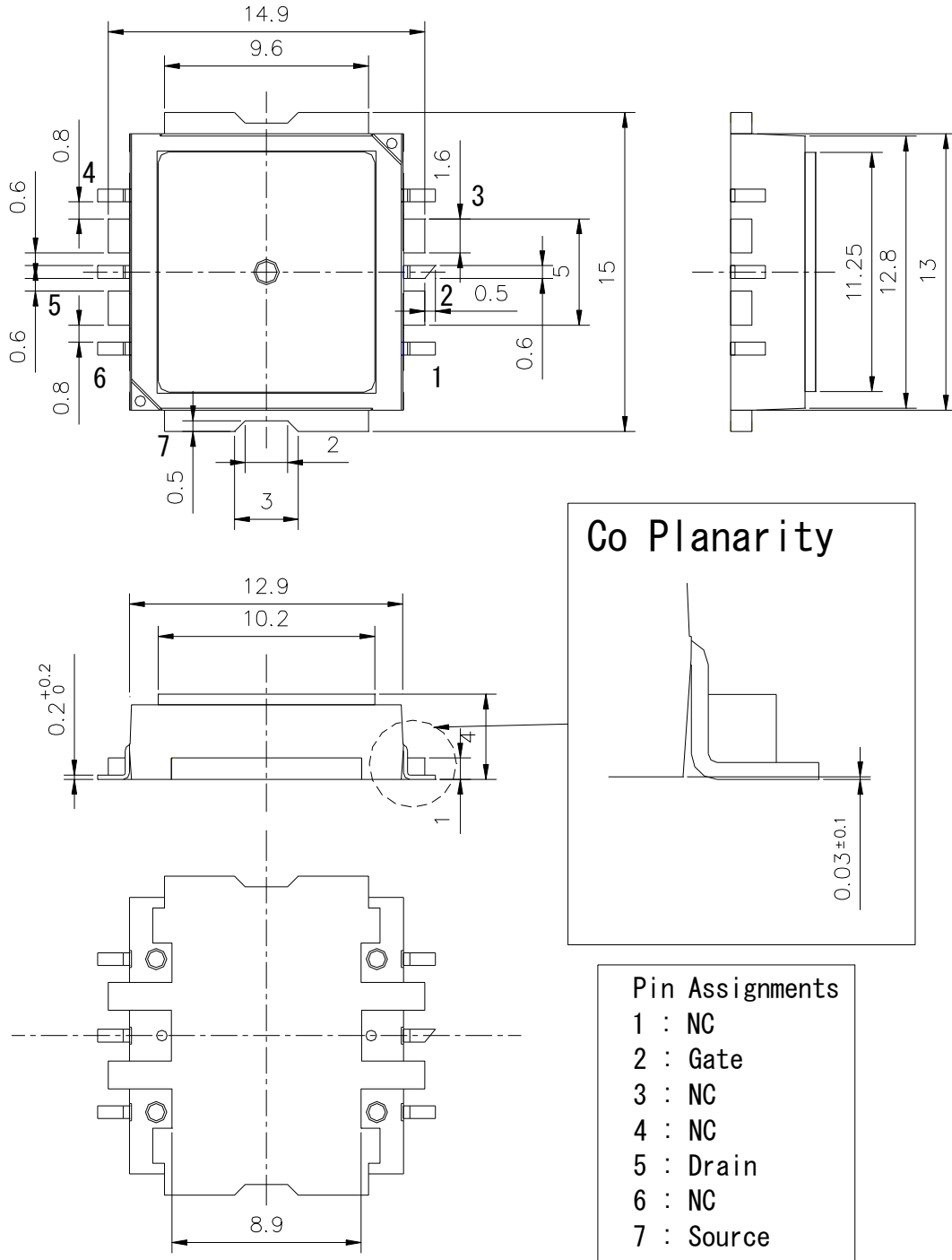

ELM7179-4PS

C-Band Internally Matched FET

● PCB Pads and Solder-Resist Pattern

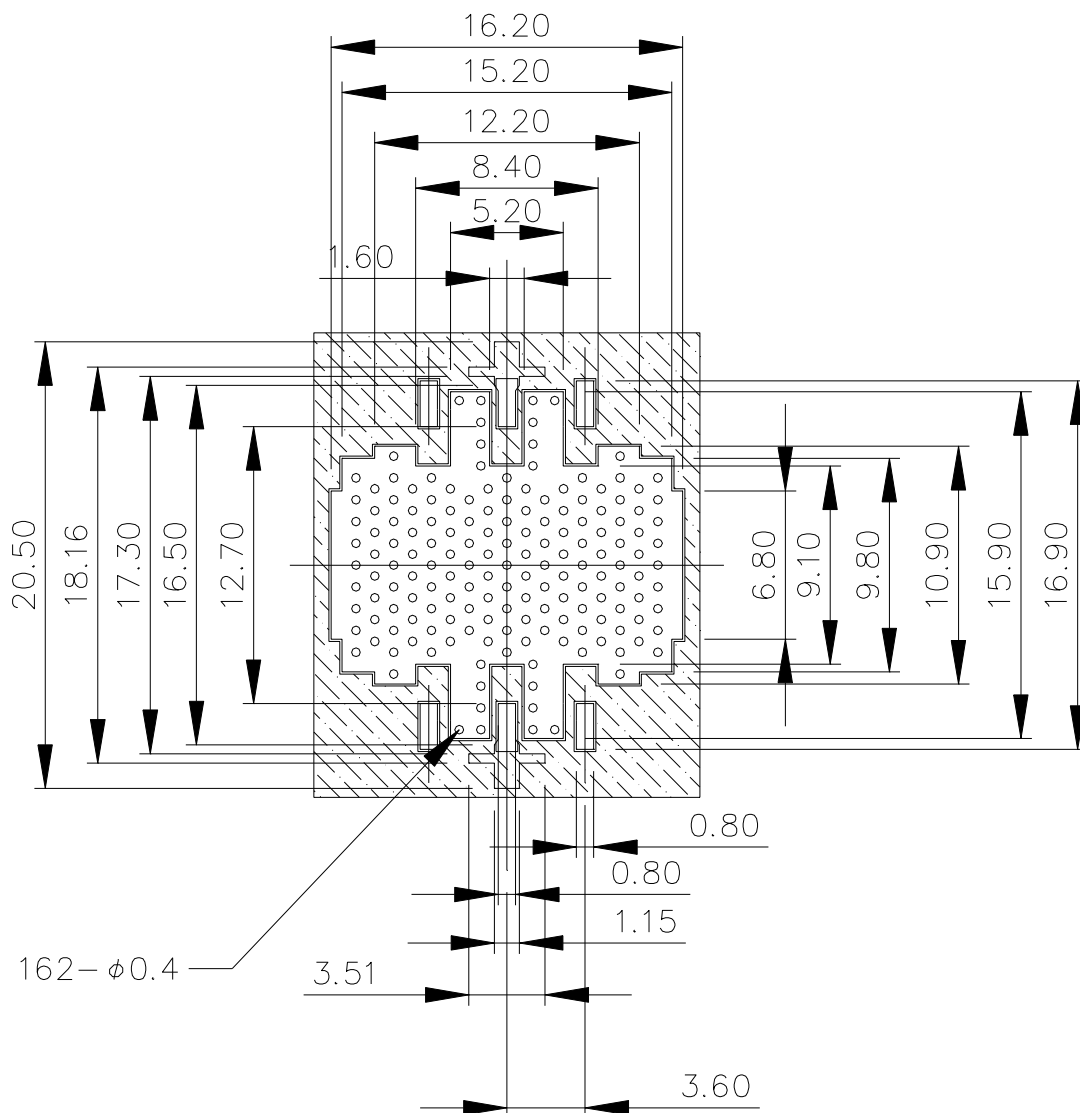

Notes :

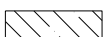
1. Laminate : Rogers Corporation R04003, Thickness $t=0.508\text{mm}$, Cu Foil $18\mu\text{m}$.
Finish to copper foil : Ni $0.1\mu\text{m}$ min. / Au $0.1\mu\text{m}$ (Both side).
2.  : Resist

● **Marking and Tape/Reel Configuration**

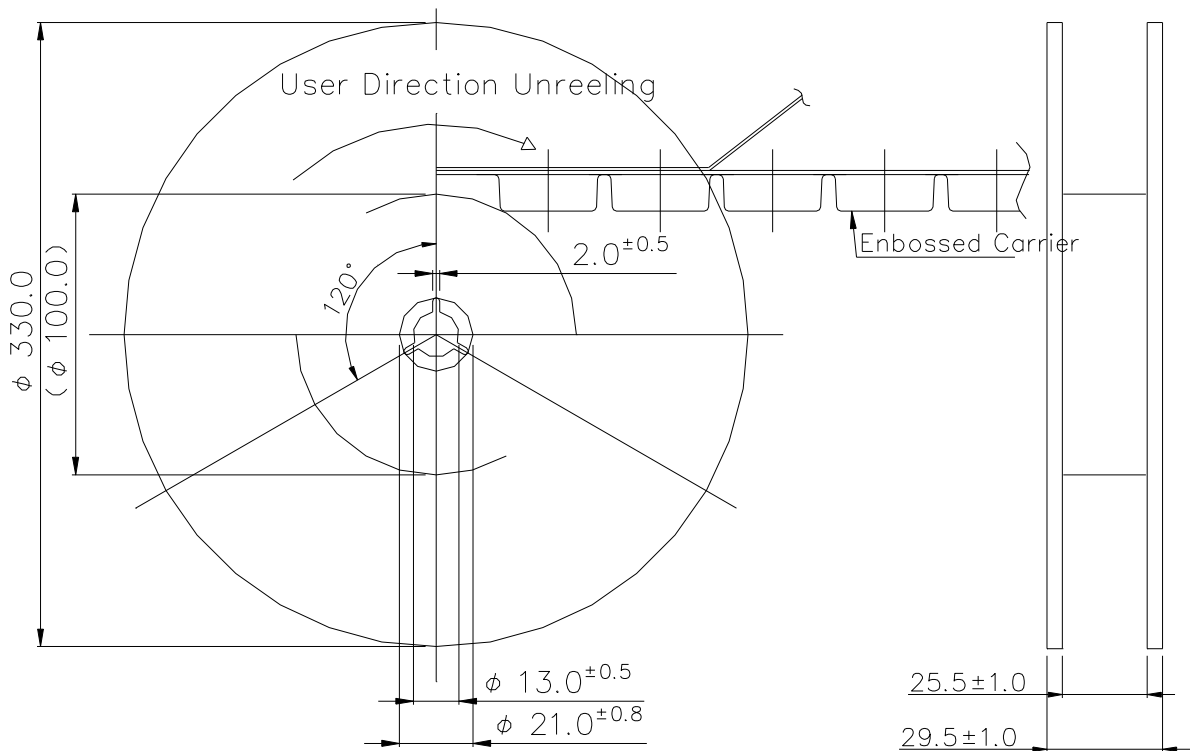
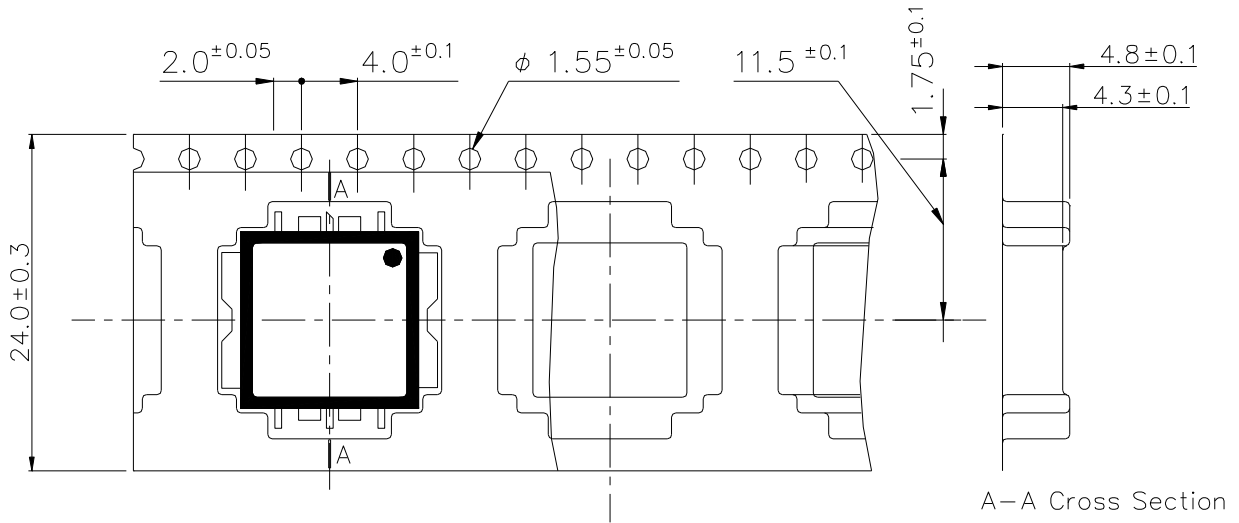

Quantity: 500pcs/tape
Tape Material: Conductive PS

(unit in mm)

ELM7179-4PS

C-Band Internally Matched FET

● Mounting Instructions for Package for Lead-free solder

Mounting Condition

For soldering, Lead-free solder (Sn-3.0Ag-0.5Cu)*1 or equivalent shall be used.

1. The example solder is a tin-rich alloy with 3.0% silver and 0.5% copper, often called Sn 96 for its approximate Tin content.
2. A rosin type flux with chlorine content of 0.2% or less shall be used. The rosin flux with low halogen content is recommended. When soldering, use the following time/ temperature profile with any of the methods listed for acceptable solder joints.
3. Make sure the devices have been properly prepared with flux prior soldering.

***Reflow soldering method (Infrared reflow / Heat circulation reflow / Hot plate reflow):**

Limit solder to 3 reflow cycles because resin is used in the modules manufacturing process.

Excessive reflow will effect the resin resulting in a potential failure or latent defect.

The recommended reflow temperature profile is shown below. The temperature of the reflow profile must be measured at the device lead.

● Reflow temperature profile and condition:

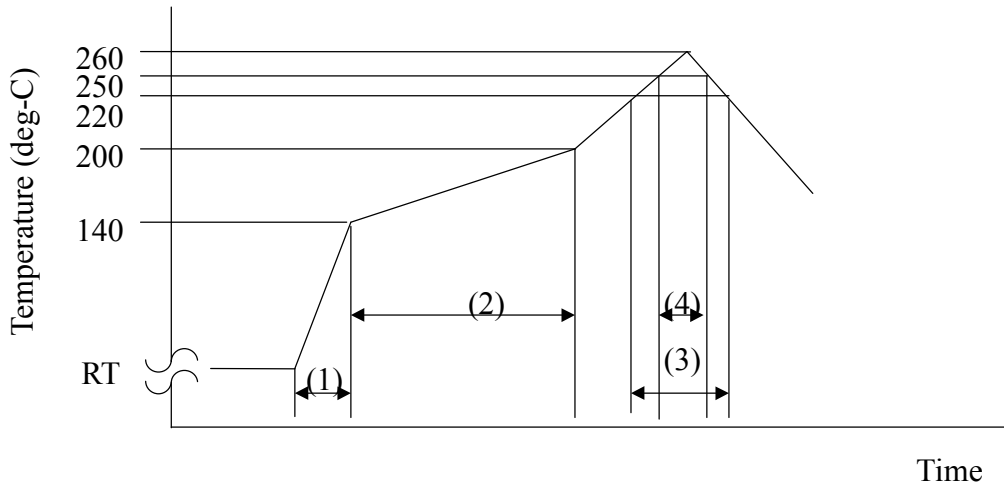

- (1). Temperature rise: 3 deg-C/seconds.
- (2). Preheating: 150 – 200 deg-C, 60 - 180seconds.
- (3). Main heating: 220 deg-C, 60 seconds max.
- (4). Main heating: 260 deg-C max., more than 250 deg-C, 20 - 40 seconds max.

* Measurement point: Device Heat-sink (Source Pin).

1. The above-recommended conditions were confirmed using the manufacturer's equipment and materials. However, when soldering these products, the soldering condition should be verified by customer using their own particular equipment and materials.

● Cleaning

Avoid washing of the device after soldering by reflow method due to the risk of liquid absorption by the resin used in this part.

Humidity Lifetime for ELMxxxx-4PST

The following graph shows the effect of moisture on lifetime (moisture resistance) for the **ELMxxxx-4PST**. Each graph indicates the MTTF and failure rate prediction (Confidential Level = 90 %) which calculated from the results of highly accelerated temperature and humidity stress test (HAST).

Representative of device type: ELM7179-4PST

Subject of device type : ELMxxxx-4PST

Field environmental conditions for operation

If the **ELMxxxx-4PST** is installed in a non-hermetic environment, please refer to the following recommendations and notes for design with, and assembly and use of our products.

- Note 1. When drain current cuts off, it should be cut off by drain bias, and not cut off by gate bias only. The humidity lifetime becomes shorter in case of the gate-only cut off operation due to electric field strength interacting with humidity.
- Note 2. **ELMxxxx-4PST** should be used under the environment conditions of no dew condensation. These plots do not apply in the case of liquid absorbed into the resin, whether applied to the part in assembly or as condensate in the application.

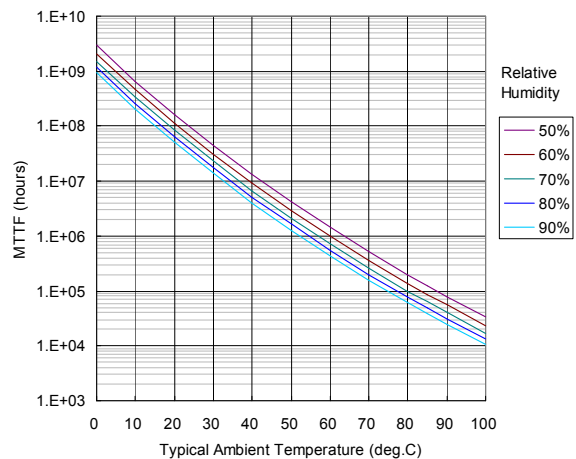
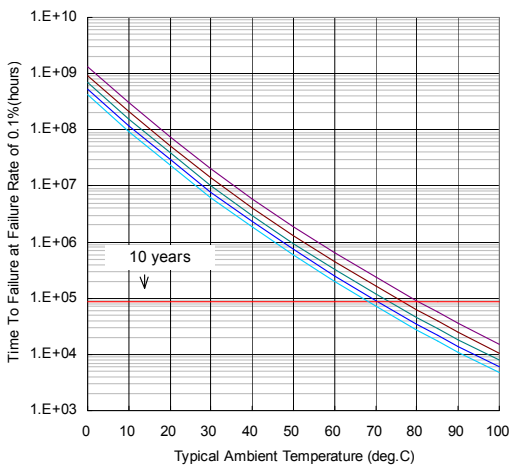

ELM7179-4PS

C-Band Internally Matched FET

For further information please contact:

**Sumitomo Electric Device
Innovations, U.S.A., Inc.**

2355 Zanker Rd.
San Jose, CA 95131-1138, U.S.A.
TEL: +1 408 232-9500
FAX: +1 408 428-9111

Sumitomo Electric Europe Ltd.

220 Centennial Park Elstree
WD6 3SL United Kingdom
TEL: +44 (0)20 8953-8118
FAX: +44 (0)20 8953-8228

**Sumitomo Electric Europe Ltd.
(Italy Branch)**

Piazza Don E. Maoelli, 60 – 20099
Sesto San Giovanni, Milano, Italy
TEL: +39-02-4963 8601
FAX: +39-02-4963 8625

Sumitomo Electric Asia, Ltd.

Room 2624-2637, 26/F,
Sun Hung Kai Centre,
30 Harbour Road, Whanchai,
Hong Kong
TEL: +852-2576-0080
FAX: +852-2576-6412

**Sumitomo Electric Device
Innovations, Inc.**

1000 Kamisukiahara, showa-cho
Nakakomagun, Yamanashi
409-3883, Japan
(Kokubo Industrial Park)
TEL +81-55-275-4411
FAX +81-55-275-9461

**Sumitomo Electric Industries, Ltd.
Head Office(Tokyo)**

3-9-1, Shibaura, Minato-ku
Tokyo 108-8539, Japan
TEL +81-3-6722-3283
FAX +81-3-6722-3284

CAUTION

- Sumitomo Electric Device Innovations, Inc. products contain gallium arsenide (GaAs) which can be hazardous to the human body and the environment. For safety, observe the following procedures:
- Do not put these products into the mouth.
- Do not alter the form of this product into a gas, powder, or liquid through burning, crushing, or chemical processing as these by products are dangerous to the human body if inhaled, ingested, or swallowed.
- Observe government laws and company regulations when discarding this product. This product must be discarded in accordance with methods specified by applicable hazardous waste procedures.

Sumitomo Electric Device Innovations, Inc. reserves the right to change products and Specifications without notice. The information does not convey any license under rights of Sumitomo Electric Device Innovations, Inc. or others.

© 2010 Sumitomo Electric Device Innovation, Inc.