

FEATURES

- Wafer Level Chip Size Package with Solder Ball
- Associated Gain : Gas=23dB (typ.)
- Output Third Order Intercept Point (OIP3) : +28dBm
- Low Current Consumption : I_{DD}=280mA
- Impedance Matched Z_{in}/ Z_{out} = 50ohm

DESCRIPTION

The SMM5848XZ is a Driver Amp MMIC for applications in the 13 to 20GHz frequency range. This product is well suited for satellite communications, radio link and wireless communications. The flip chip die can be used in solder reflow process. Sumitomo's stringent Quality Assurance Program assures the highest reliability and consistent performance.

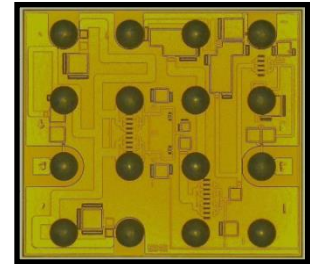

ABSOLUTE MAXIMUM RATING

Item	Symbol	Rating	Unit
Drain-Source Voltage	V _{DD}	4	V
Gate-Source Voltage	V _{GC}	-3	V
Input Power	P _{in}	4	dBm
Storage Temperature	T _{stg}	-55 to +125	deg.C

RECOMMENDED OPERATING CONDITIONS

Item	Symbol	Condition	Unit
Drain-Source Voltage	V _{DD}	=< 3	V
Input Power	P _{in}	=< 0	dBm
Operating Case Temperature	T _C	-40 to +85	deg.C

ELECTRICAL CHARACTERISTICS (Case Temperature T_c=25deg.C)

Item	Symbol	Test Conditions	Limits			Unit
			Min.	Typ.	Max.	
Frequency Range	f	V _{DD} =3.0V	12.7	-	19.7	GHz
Gate Bias Voltage	V _{GC} (DC)	I _{DD} (DC)=280mA typ.	-0.5	-0.2	0	V
Output Power at 1dB G.C.P.	P _{1dB}	Z _s =Z _l =50ohm	-	18.0	-	dBm
Power Gain at 1dB G.C.P.	G _{1dB}		-	22.0	-	dB
Associated Gain*	Gas		20.0	23.0	-	dB
Power-added Efficiency at 1dB G.C.P.	PAE		-	10	-	%
Output Third Order Intercept Point*	OIP3		26	28	-	dBm
Drain Current at 1dB G.C.P.	I _{DD} (RF)		-	280	-	mA
Input Return Loss at Pin=-20dBm	RL _{in}		-	8	-	dB
Output Return Loss at Pin=-20dBm	RL _{out}		-	8	-	dB

*P_{out}= 10dBm (2tone)

G.C.P. : Gain Compression Point

GAIN vs. RF FREQUENCY

@ $V_{DD}=3V$, $I_{DD}=280mA$, $T_C=+25deg.C$, $P_{in}=-20dBm$

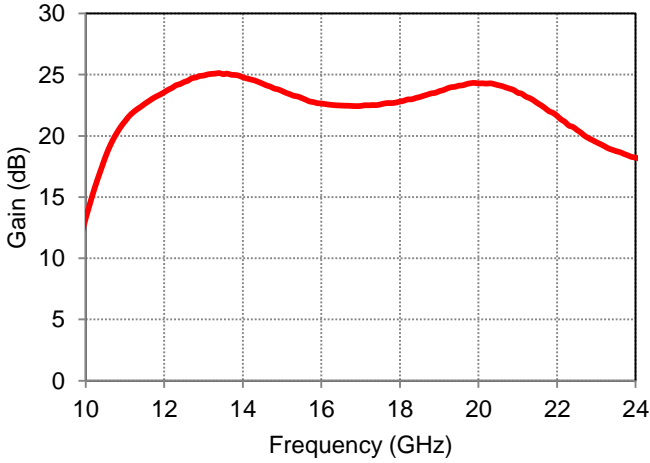

OUTPUT IP3 vs. RF FREQUENCY

@ $V_{DD}=3V$, $I_{DD}=280mA$, $T_C=+25deg.C$, $P_{out}=10dBm$ (2-tone)

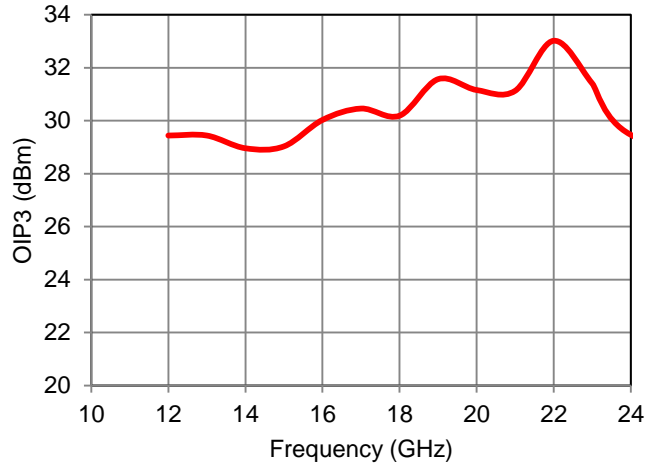

IMD vs. OUTPUT POWER

@ $V_{DD}=3V$, $I_{DD}=280mA$, $T_C=+25deg.C$, $P_{out}=10dBm$ (2-tone)

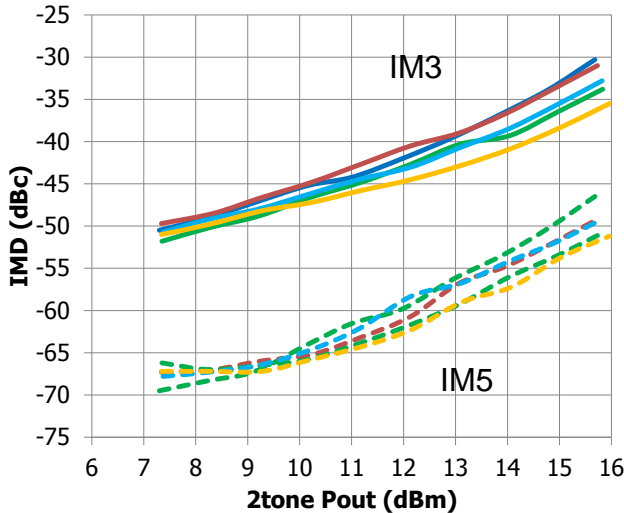

— Freq=12GHz — 14GHz — 16GHz
— 18GHz — 20GHz

OUTPUT POWER vs. INPUT POWER

@ $V_{DD}=3V$, $I_{DD}=280mA$, $T_C=+25deg.C$

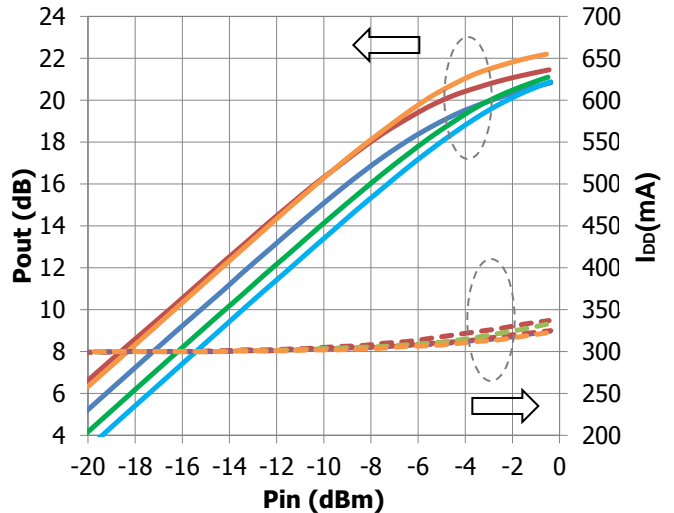

— Freq=12GHz — 14GHz — 16GHz
— 18GHz — 20GHz

INPUT RETURN LOSS

@ $V_{DD}=3V, I_{DD}=280mA, T_C=+25deg.C$

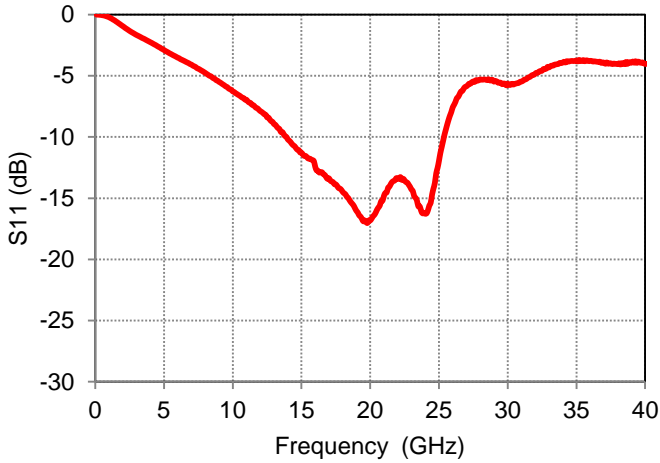

OUTPUT RETURN LOSS

@ $V_{DD}=3V, I_{DD}=280mA, T_C=+25deg.C$

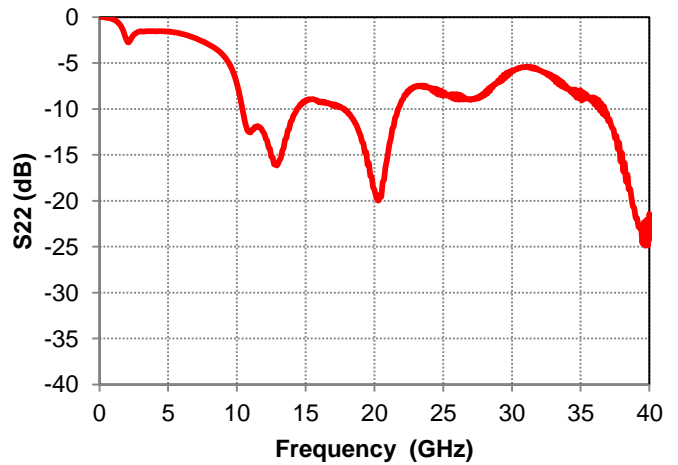

FORWARD TRANSMISSION

@ $V_{DD}=3V, I_{DD}=280mA, T_C=+25deg.C$

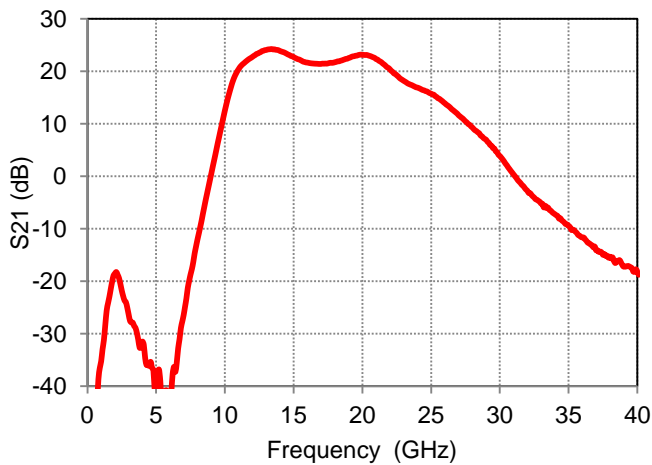

OUTPUT POWER vs. RF FREQUENCY

@ $V_{DD}=3V, I_{DD}=280mA, T_C=+25deg.C$

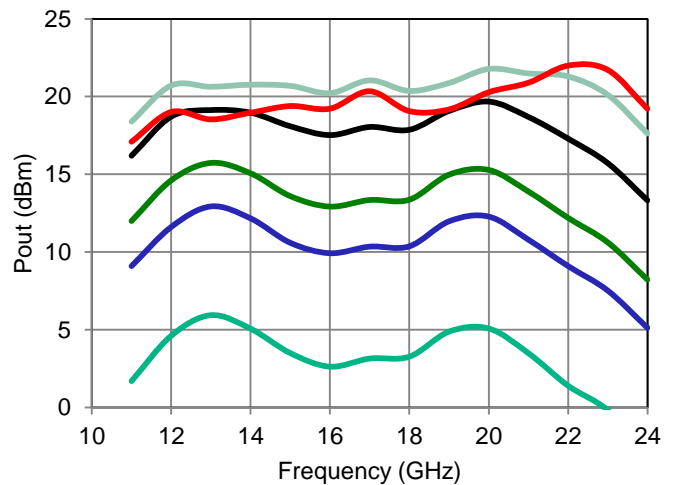

— Pin=-20dBm
 — -14dBm
 — -10dBm
— -5dBm
 — 0dBm
 — P1dB

P1dB, G1dB vs. I_{DD}

@ V_{DD}=3V, T_C=+25deg.C

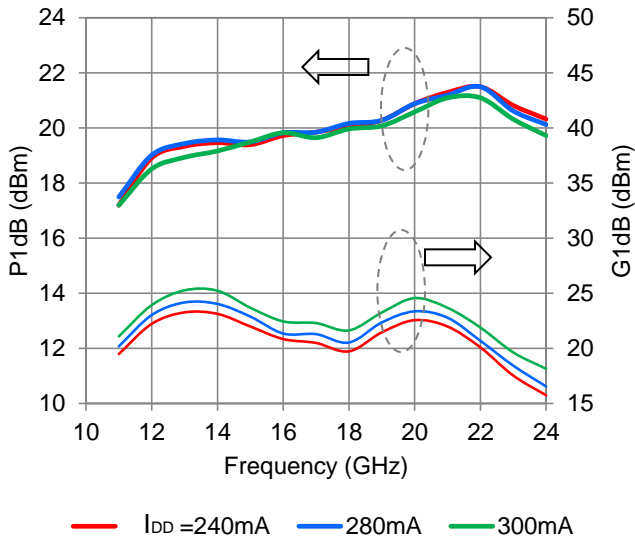

OUTPUT IP3 vs. I_{DD}

@ V_{DD}=3V, P_{out}=10dBm(2tone), T_C=+25deg.C

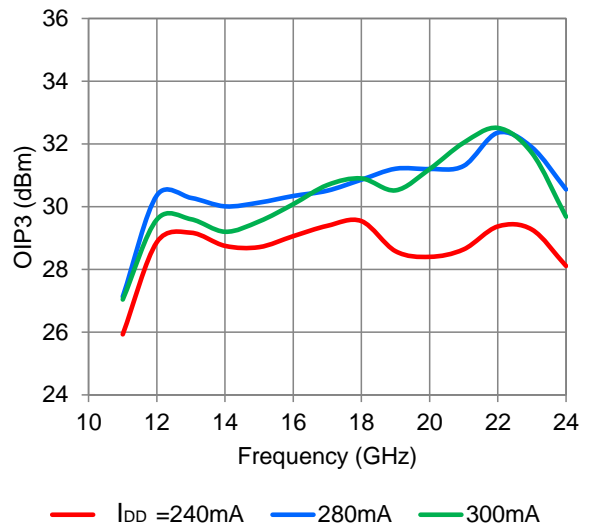

OUTPUT POWER vs. I_{DD}

@ Freq.=13GHz, V_{DD}=3V, I_{DD}=280mA, T_C=+25deg.C

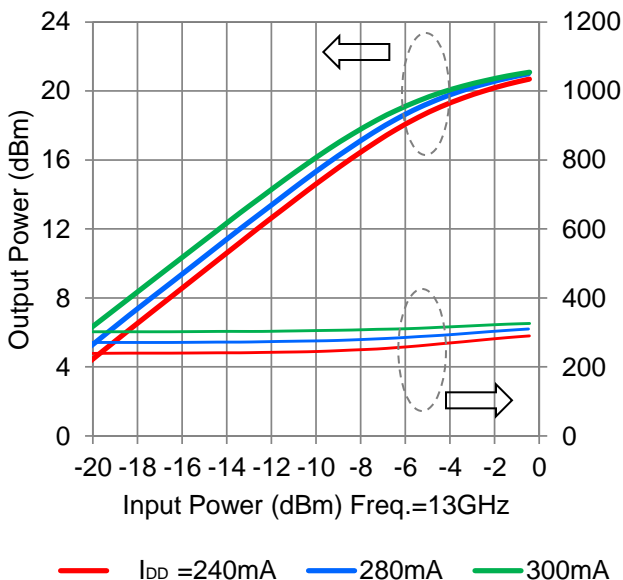

OUTPUT POWER vs. I_{DD}

@ Freq.=18GHz, V_{DD}=3V, I_{DD}=280mA, T_C=+25deg.C

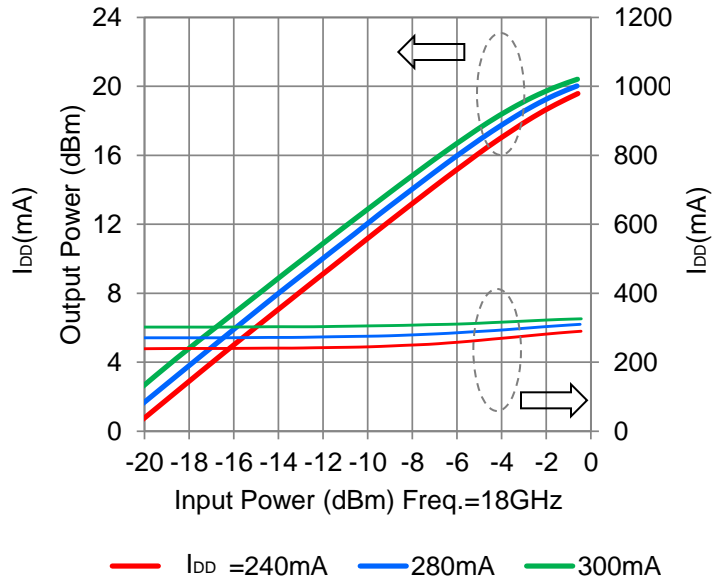

P1dB, G1dB vs. TEMPERATURE

@ $V_{DD}=3V, I_{DD}=280mA$

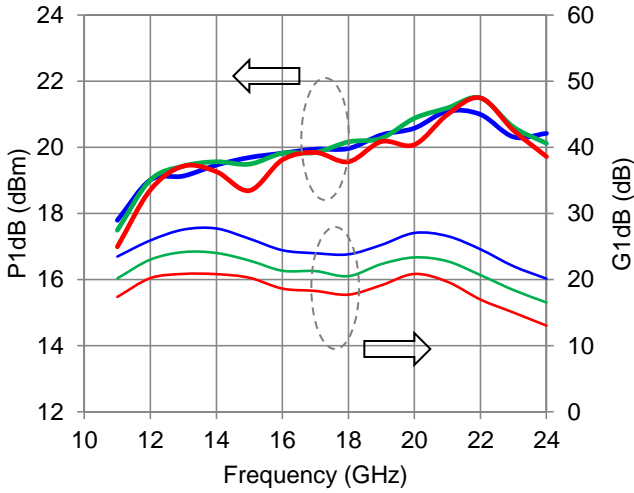

— -40deg.C — 25deg.C — 85deg.C

OUTPUT IP3 vs. TEMPERATURE

@ $V_{DD}=3V, I_{DD}=280mA, P_{out}=10dBm(2tone)$

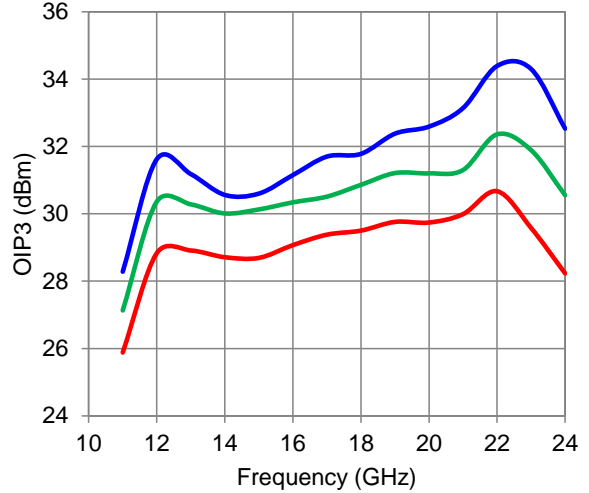

— -40deg.C — 25deg.C — 85deg.C

OUTPUT POWER vs. TEMPERATURE

@ Freq.=13GHz, $V_{DD}=3V, I_{DD}=280mA$

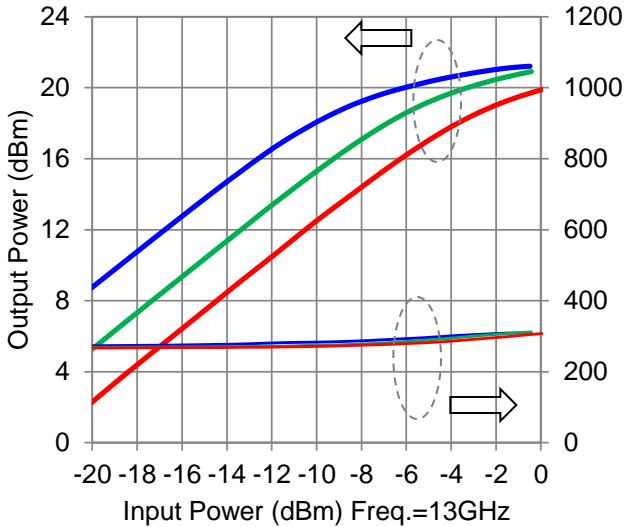

— -40deg.C — 25deg.C — 85deg.C

OUTPUT POWER vs. TEMPERATURE

@ Freq.=18GHz, $V_{DD}=3V, I_{DD}=280mA$

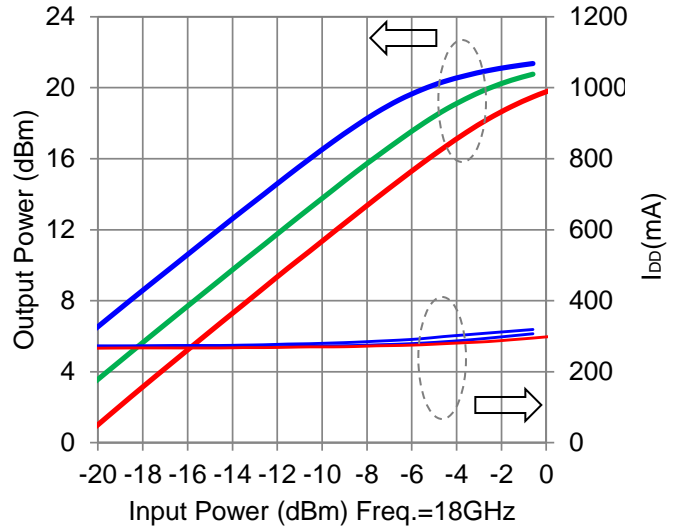

— -40deg.C — 25deg.C — 85deg.C

■ Chip Outline and Functional Diagram

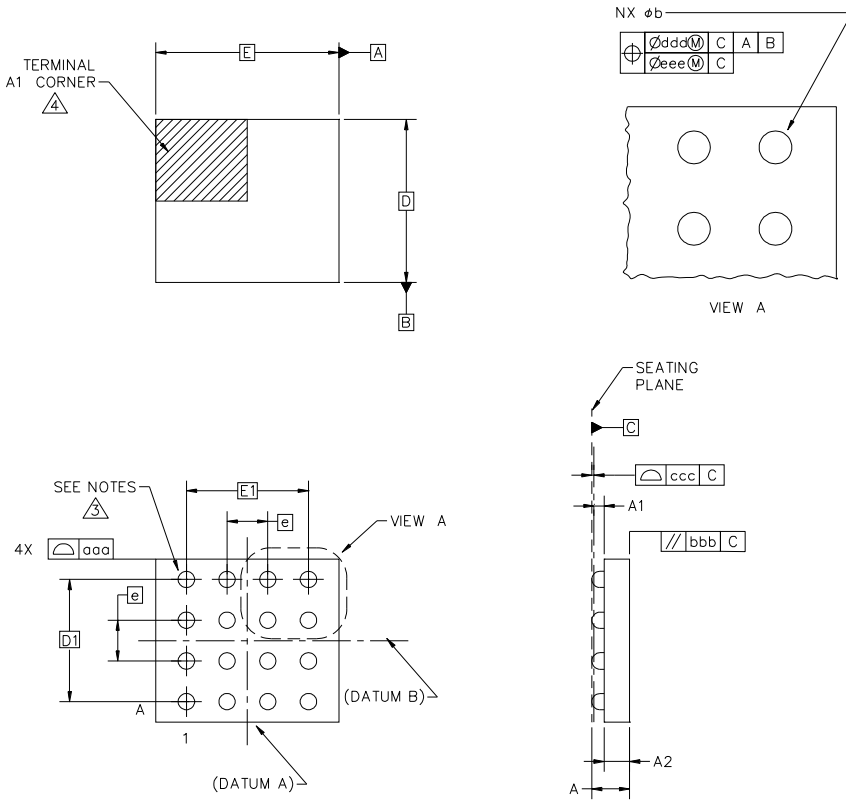

Symbol	Dimensions (typ.)	Note
A	0.396	
A1	0.121	
A2	0.275	
b	0.168	
D	1.57	
D1	1.20	
E	1.77	
E1	1.20	
e	0.40	
MD	4	
ME	4	
N	16	
aaa	0.07	
bbb	0.046	
ccc	0.03	
ddd	0.07	
eee	0.03	

NOTES :

1. DIMENSIONING AND TOLERANCING PER ASME Y14.5M-1994
2. ALL DIMENSIONS ARE IN MILLIMETERS
3. BALL DESIGNATION PER JEDEC STD MS-028 AND JEP95
4. DETAILS OF PIN #1 IDENTIFIER ARE OPTIONAL, BUT MUST BE LOCATED WITHIN THE ZONE INDICATED.
5. PRIMARY DATUM C IS SEATING PLANE
6. ALLOY OF SOLDER BALL : Sn-3.0Ag-0.5Cu

■ Pin Assignment

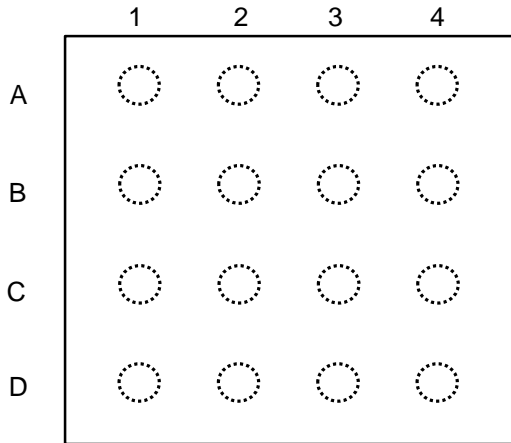

	1	2	3	4
A	V _{Gc}	GND	V _{DD1}	V _{DD2}
B	GND	GND	GND	GND
C	RF in	GND	GND	RF out
D	GND	GND	V _{DD3}	GND

Bump Side Down (Die Top View)

■ Marking

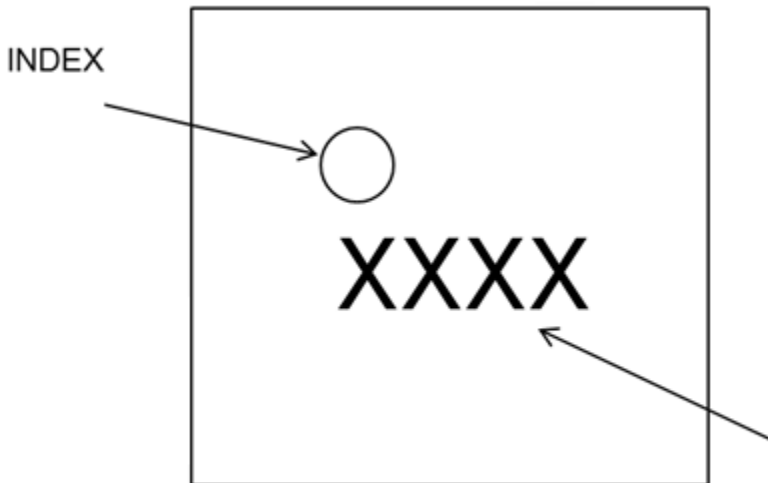

Part Number
(ex SMM5848XZ → 5848)

Bump Side Down (Die Top View)

■ Application Circuit Block Diagram

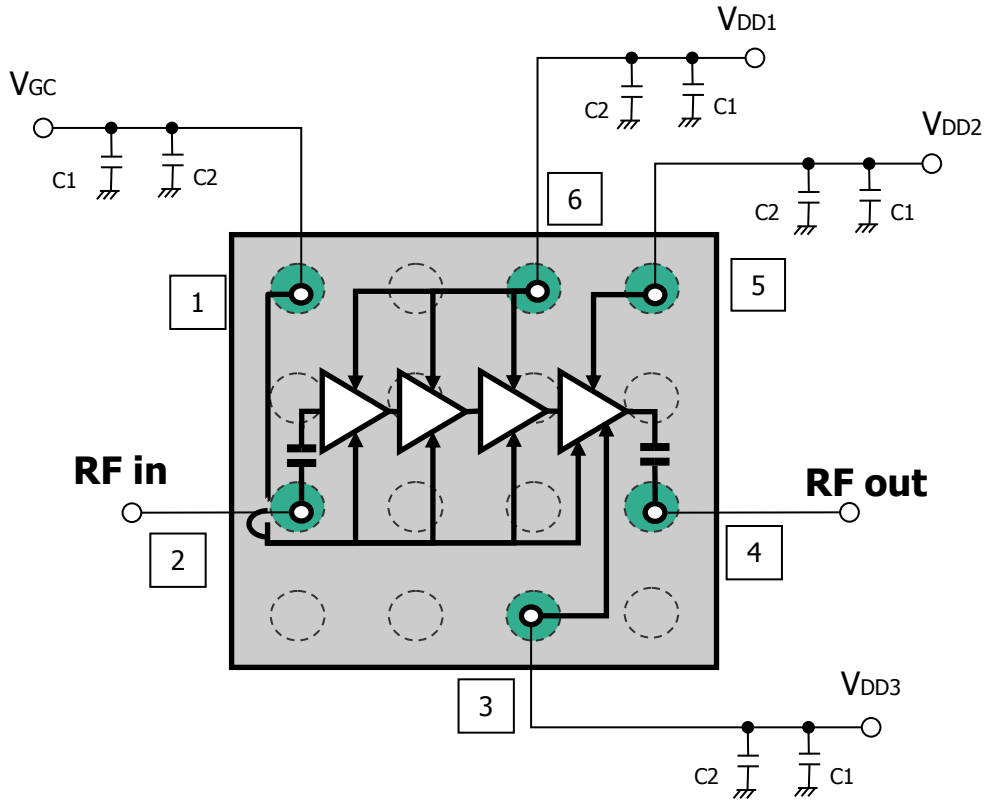

Pin Assignment

Pin	Name
1	V _{GC}
2	RF in
3	V _{DD3}
4	RF out
5	V _{DD2}
6	V _{DD1}

Component List

Name	Description	Value
C1	Capacitor	0.1uF
C2	Capacitor	100pF

*All bumps except Pin 1 to 6 are GND

■ 2-inch Tray Packing (Part No. : SMM5848XZ)

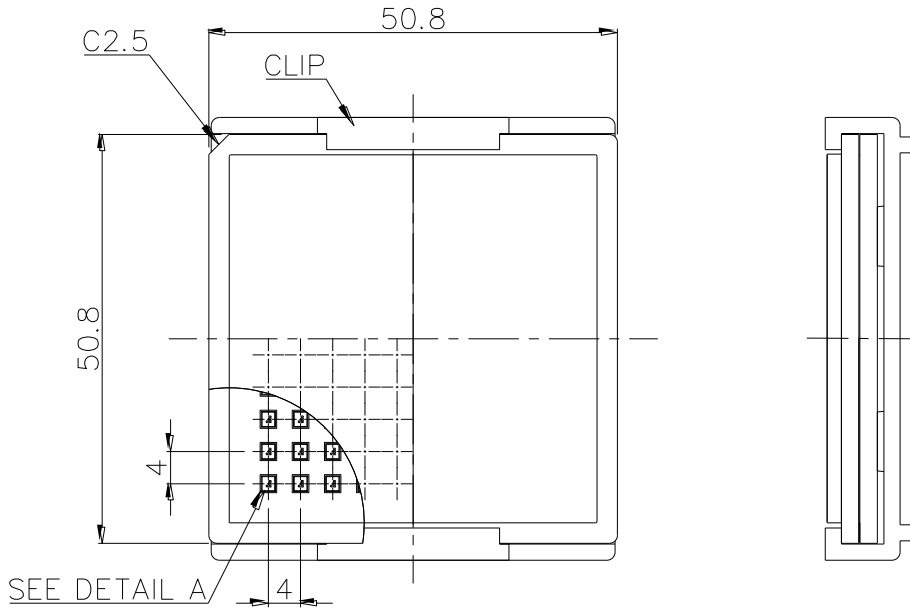

SEE DETAIL A

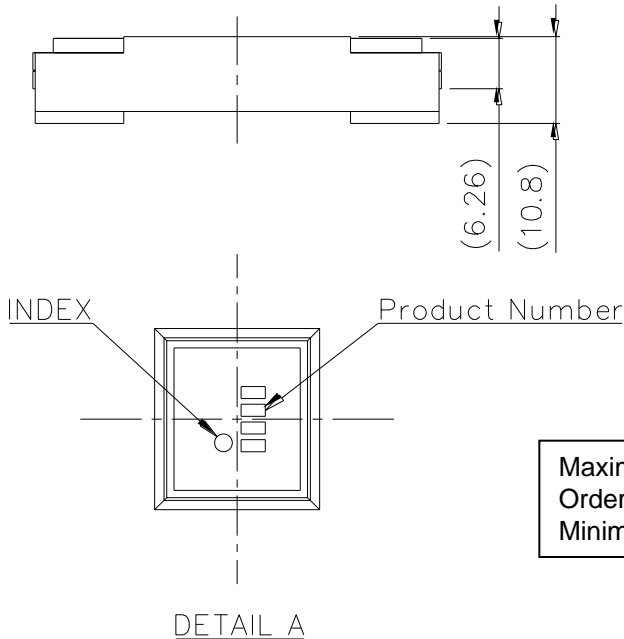

<p>Maximum Quantity : 100 pcs. / Tray Ordering Unit : 100 pcs. / order Minimum Ordering Unit : 100 pcs. (1 Tray)</p>

■ Tape and Reel Packing (Part No. : SMM5848XZT)

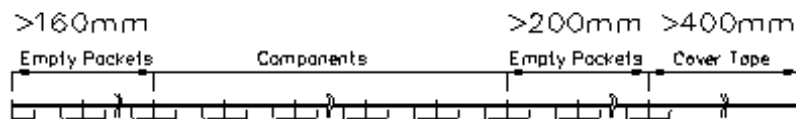
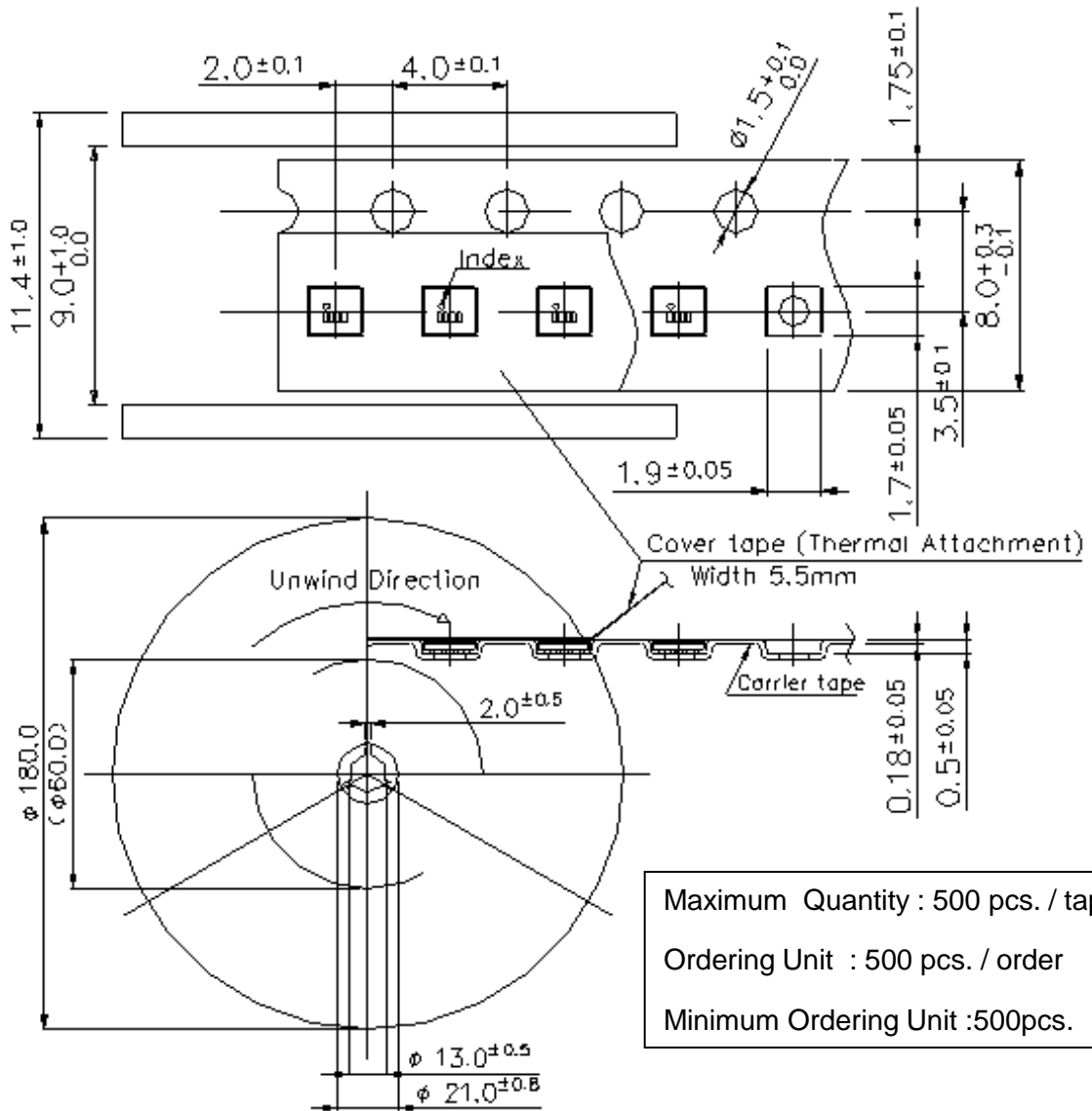

■ Assembly Techniques for WLCSP MMICs

1. WLCSP Assembly Flow

WLCSP MMIC can be handled as a standard SMT component as following assembly flow.

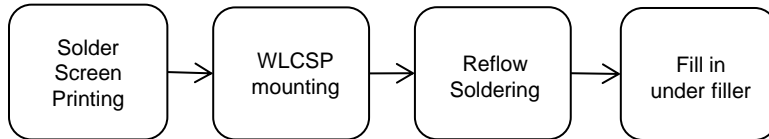

It also can make use C4 (Controlled Collapse Chip Connection) assembly techniques or a flux dip assembly method. In this case lower residue flux is recommended to save cleaning process.

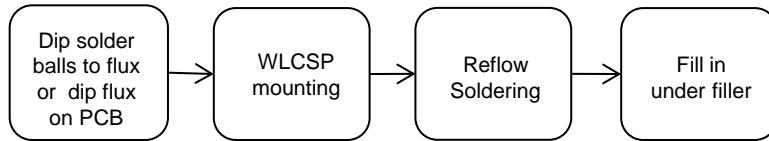

2. PCB Layout

PCB land patterns are based on SEI's experimental data. The land pattern has been developed and tested for optimized assembly at SEI. Especially, solid-filled via is used to prevent depletion of the solder of solder past and solder ball from ground pad through via holes during reflow soldering process. To prevent short between solder balls, solder mask resist should be used. A recommended PCB layout is shown on page figure 6.

3. Stencil Mask

The use of solder mask is required to put WLCSP MMIC on PCB in the standard SMT assembly technics. The stencil mask design is critical. A minimum solder mask space is 0.16mm between solder balls must be used to prevent shorting. To realize stable solder volume, A stencil thickness and opening need to be optimized. A recommended stencil mask pattern is shown in Fig. 1.

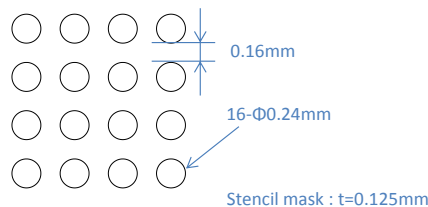

Figure 1

■ Assembly Techniques for WLCSP MMICs

4. Die Mounting

For WLCSP MMIC with fine pitch of 0.4mm, it is recommended to use automated fine-pitch placement. Due to the variety of mounting machines and parameters and surface mount processes vary from company to company, careful process development is recommended.

5. Reflow Soldering

The solder reflow condition (infrared reflow/heat circulation reflow/hotplate reflow) shall be optimized and verified by the customer within the condition shown in Fig.2 to realize optimum solderability. An excessive reflow condition can degrade the WLCSP MMICs that may result in device failure. The solder reflow must be limited to three (3) cycles maximum. The temperature profile during reflow soldering shall be controlled as shown in Fig.2.

Customers shall optimize and verify the reflow condition to meet their own mounting method using their own equipment and materials. For any special application, please contact the Sumitomo sales office nearest you for information.

Certain types of PCB expand and contract causing crooks and waves in the board material during the reflow cycle. The recommended measure to prevent this from occurring is to screw the PCB onto a board with a small heat capacity prior to the reflow process.

The solder balls of WLCSP MMIC is used Pb-free alloy and the melting point of Sn/Ag/Cu would be 218deg.C. The actual profile used depends on the thermal mass of the entire populated board and the solder compound used.

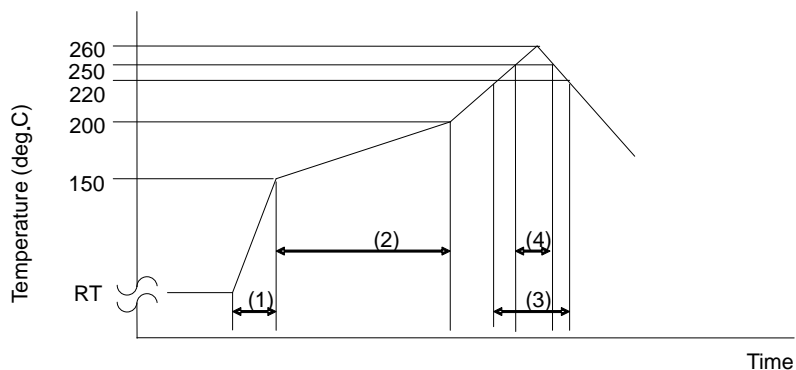

Average Ramp-up Rate	: 3deg.C/seconds
Preheating	: 150 to 200deg.C , 60 to 80seconds
Main Heating	: 220.deg.C , 60seconds
Peak Temperature	: 260deg.C max , more than 250deg.C , 10seconds max.

Figure 2

■ Assembly Techniques for WLCSP MMICs

6. Cleaning

Do not handle to clean WLCSP MMIC in liquid cleaning system. If it is required, please contact <http://global-sei.com/Electro-optic/about/office.html>.

7. Underfill Process

WLCSP MMIC is connected to PCB by solder balls. A major concern in using WLCSP MMICs is the ability of the solder balls to withstand temperature cycling. It is thought the stress to the solder balls by the difference of the expansion and contraction of the materials that GaAs and PCB are different is a cause. To reduce this stress, it must be consideration to use underfill to an aperture between WLCSP die and PCB. It has beneficial reliability test results in temperature cycle, drop test and mechanical stress test. The other side, it is undesirable due to complexity process and assembly cost from added process. It need to decide to use this process from test results by assembler.

8. ESD Protection

Semiconductor devices are sensitive to static electricity. User must pay careful attention to the following precautions when handling semiconductor devices.

Customers should lay a conductive mat on the bench. When handling the products of ESD class 0, customers should lay a conductive mat on the floor. And, user should periodically check the resistance of conductive mat surface and grounding condition.

Follow ESD precautions to protect against > HBM $\pm 250V$ ESD strike.

ESD	Class 0B	125 to < 250V
Note: Based on JEDEC JS-001-2012 (C=100pF, R=1.5kohm)		

9. RoHS Compliance

RoHS Compliance	Yes
------------------------	------------

10. Handling of WLCSP MMICs in Tape and Reel From

Peel the carrier tape and the top tape off slowly at a rate of 10 mm/s or less to prevent the generation of electro-static discharge. When peeling the tape off, the angle between the carrier tape and the top tape should be kept at 165 to 180 degrees as shown in Fig. 3.

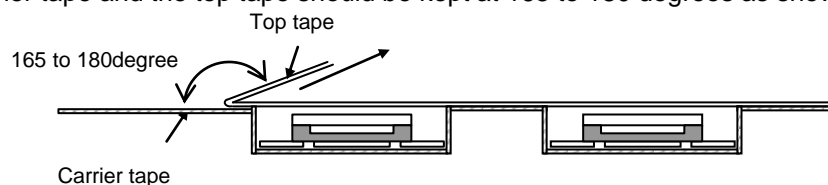

Figure 3

■ Assembly Techniques for WLCSP MMICs

11. Packing

The WLCSP MMICs are provided by tape and reel or tray in a bump-down configuration.

ORDERING INFORMATION

Part Number	Order Unit	Packing
SMM5848XZ	100 pcs.	100pcs. / Tray = 100pcs. / Packing
SMM5848XZT	500 pcs.	500pcs. / Reel = 500pcs. / Packing

- NOTE -

This information is described as reference information based on SEI experimental test like assembly process, PCB and stencil design, Temperature cycle test result and so on.

SEI can not guarantee the quality of WLCSP after customer own assembly process because assembly and PCB condition is difference between customer and SEI.

Please check the quality of device (or system) after customer assembles with customer's PCB and assembly process.



SMM5848XZ

13 - 20GHz Driver Amplifier MMIC

For further information please contact:

<http://global-sei.com/Electro-optic/about/office.html>

CAUTION

This product contains **gallium arsenide (GaAs)** which can be hazardous to the human body and the environment. For safety, observe the following procedures:

- Do not put these products into the mouth.
- Do not alter the form of this product into a gas, powder, or liquid through burning, crushing, or chemical processing as these by-products are dangerous to the human body if inhaled, ingested, or swallowed.
- Observe government laws and company regulations when discarding this product. This product must be discarded in accordance with methods specified by applicable hazardous waste procedures.