

FEATURES

- Wafer Level Chip Size Package with Solder Ball
- 25dB Gain
- Output power of 17 dBm at 1dB gain compression
- 24.5 dBm output Third Order Intercept (OIP3)

DESCRIPTION

The Power Amplifier is an eight stage GaAs HEMT MMIC which operates between 71 and 76 GHz .

The Power Amplifier features small signal gain of 25dB, output power of 17 dBm at 1dB gain compression and saturated power of 20 dBm.

The flip chip die can be used in solder reflow process.

Sumitomo's stringent Quality Assurance Program assures the highest reliability and consistent performance.

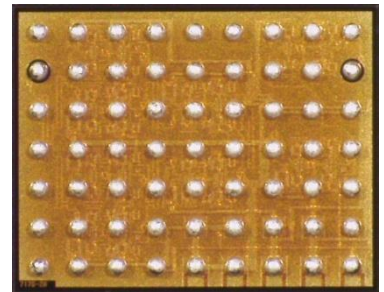

ABSOLUTE MAXIMUM RATING

Item	Symbol	Rating	Unit
Drain Voltage	V_D	7	V
Gate Voltage	V_G	-4 to 4	V
Input Power Level	P_{in}	+15	dBm
Storage Temperature	T_{sg}	-40 to +125	deg.C

RECOMMENDED OPERATING CONDITIONS

Item	Symbol	Condition	Unit
Drain Voltage	V_D	6	V
Gate Voltage	V_G	-3 to 3	V
Input Power Level	P_{in}	Up to -5	dBm
Operating Backside Temperature	Top	-40 to +85	deg.C

ELECTRICAL CHARACTERISTICS (Case Temperature $T_c=25\text{deg.C}$)

Item	Symbol	Test Conditions	Limits			Unit
			Min.	Typ.	Max.	
Frequency Range	f	$V_{D1}=V_{D2}=V_{D3}=6V$	71	-	76	GHz
Gain	Ga	$I_b = 410\text{mA}^*$	19.5	25.0	32.0	dB
Output Power at 1dB G.C.P.	P1dB		-	17	-	dBm
Saturation Power	Psat		17	20	-	dBm
3rd Order Output Intercept Point	OIP3		20.5	24.5	-	dBm
Noise Figure	NF		-	12	-	dB
Input Return Loss	RL_{IN}		-	8	-	dB
Output Return Loss	RL_{OUT}		-	12	-	dB
Total Current Consumption	I_b		-	410	-	mA

* : Adjust V_G Voltage between -3 to 3V to set to $I_b=I_{b1}+I_{b2}+I_{b3}=410\text{mA}$

G.C.P. : Gain Compression Point

Note: RF parameter sample size 22 pcs. / Wafer, Criteria (accept/reject)=(0/1)

Evaluation Board and Measurement Information

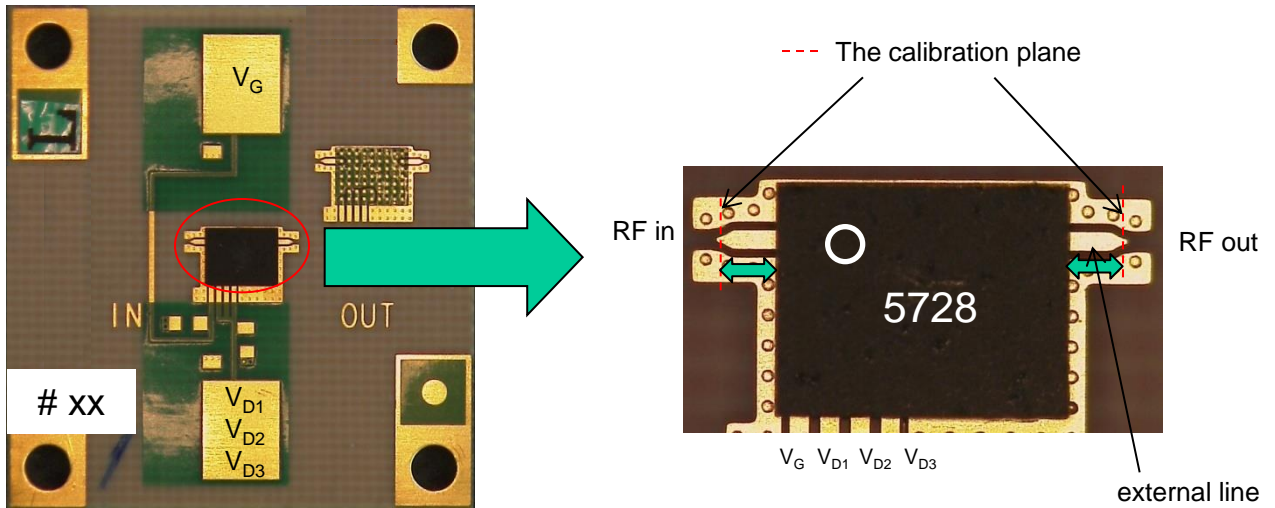

$$V_{D1}=6V$$

$$V_{D2}=V_{D3}=6V$$

All test data were measured at above calibration point (not compensated the external line loss).

The external line loss is 0.2 dB @76 GHz.

Linear Gain and Return vs. Frequency

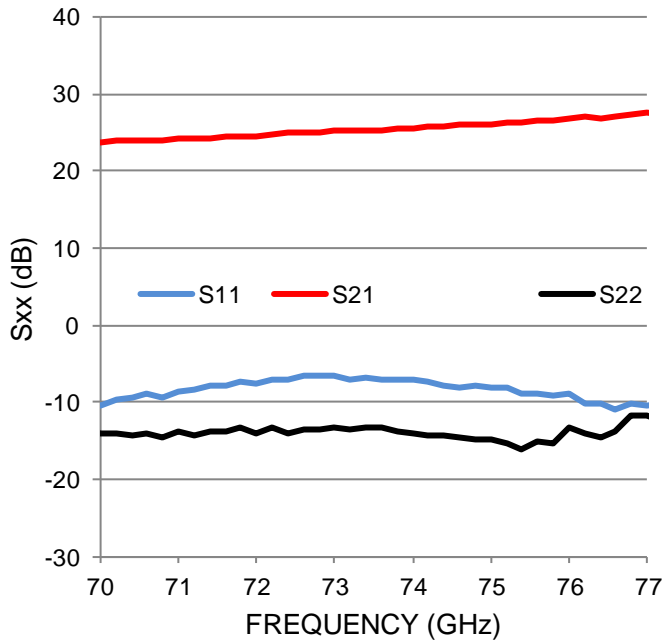

$V_{D1}=V_{D2}=V_{D3}=6V$
 $I_D=410\text{ mA}$

Linear Gain vs. I_D

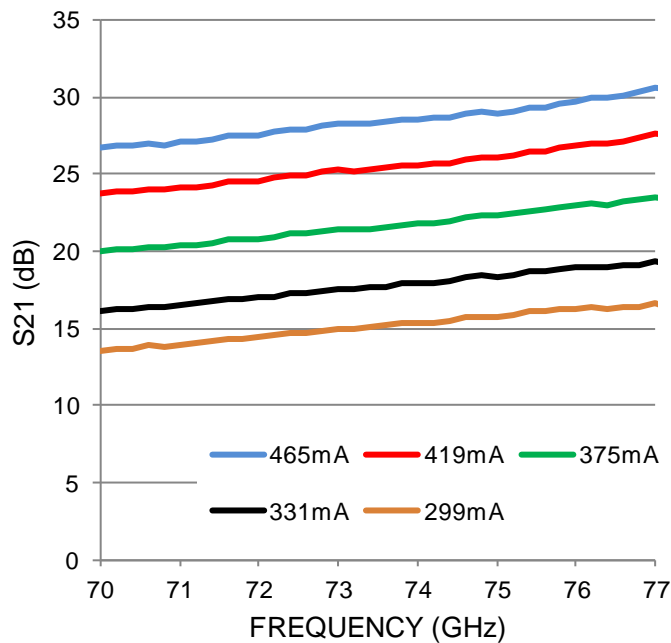

$V_{D1}=V_{D2}=V_{D3}=6V$

Linear Gain vs. Temperature

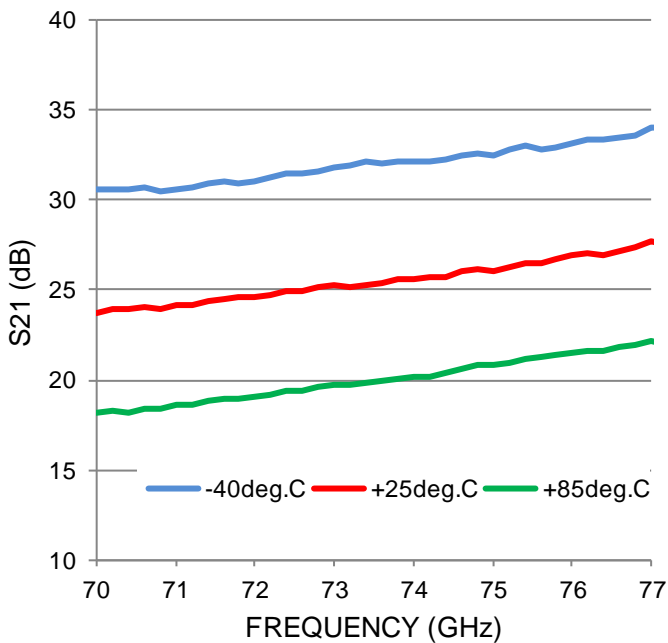
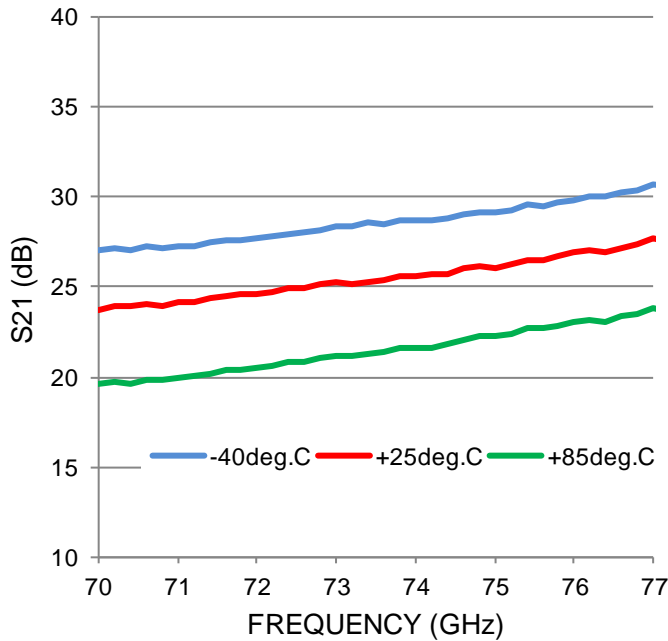

Output Power vs. Input Power by I_D

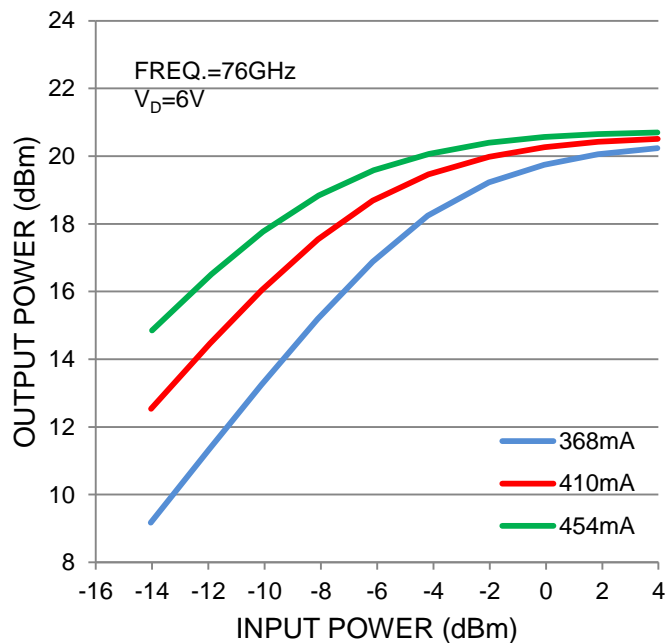
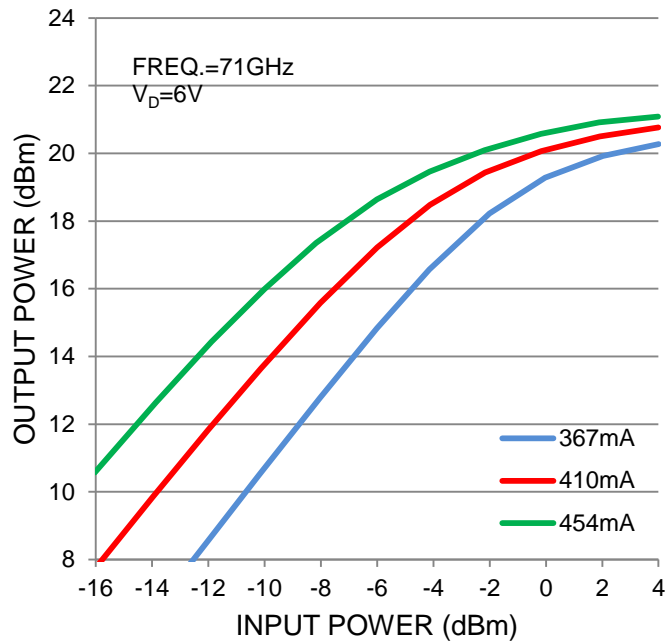

Output Power vs. Input Power by Temperature

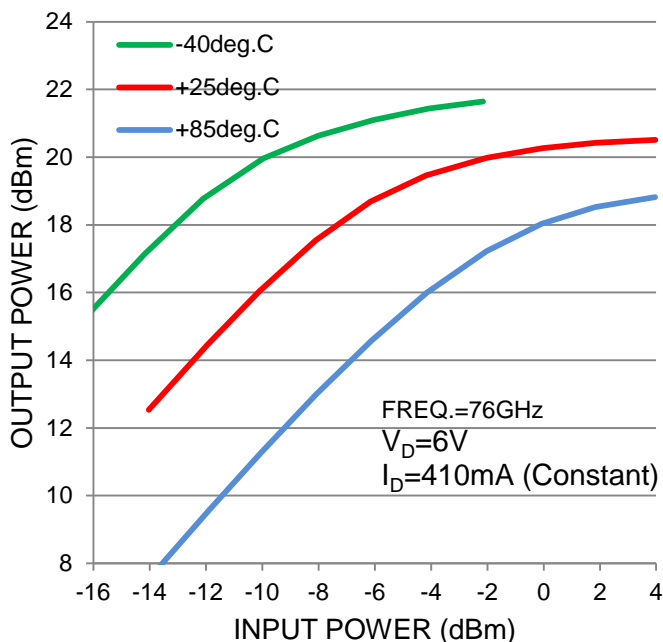
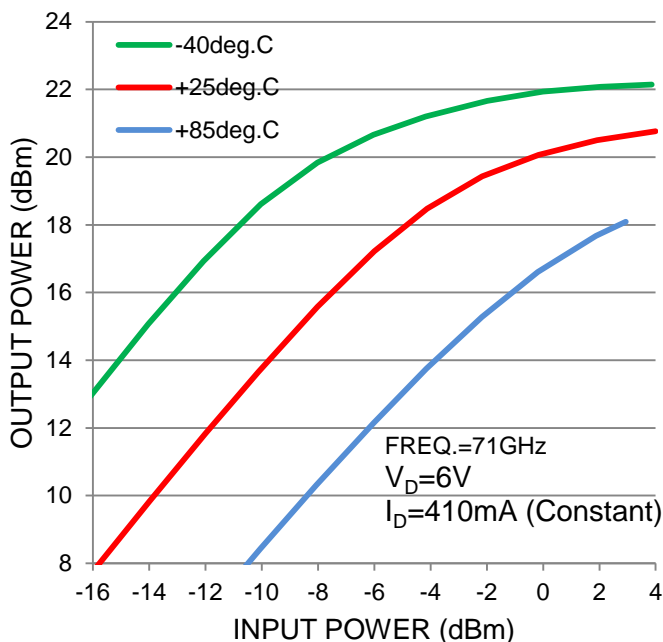
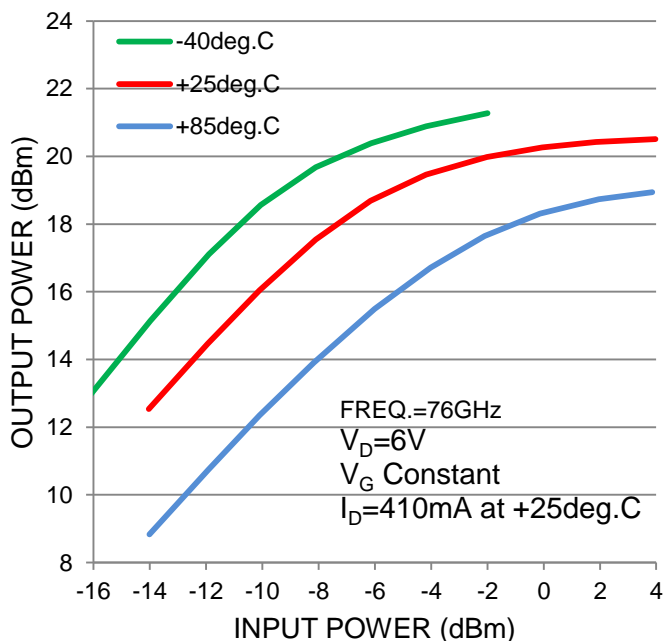
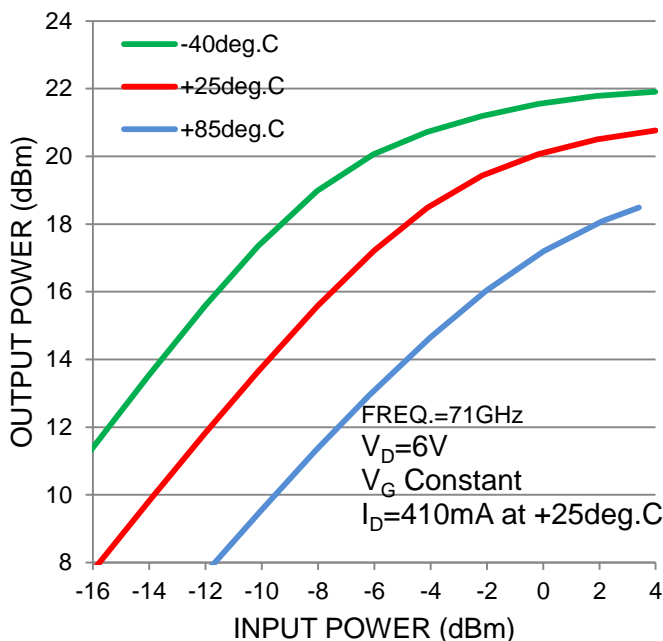

IM3 vs. Output Power by I_D

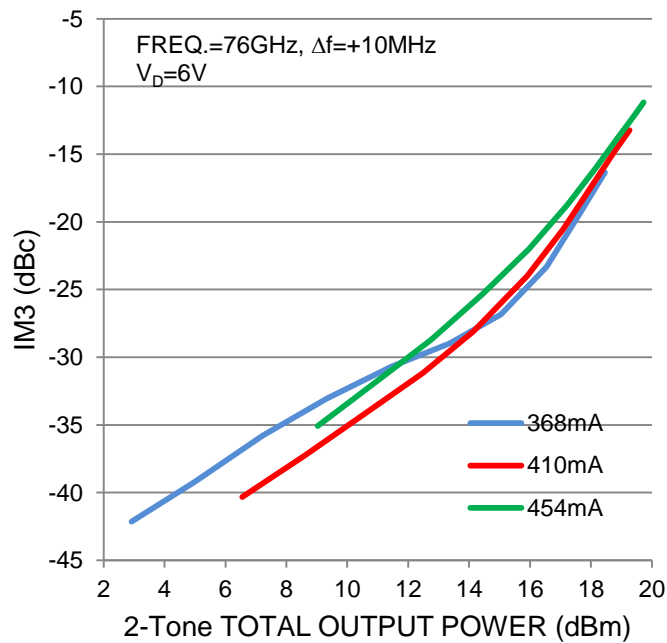
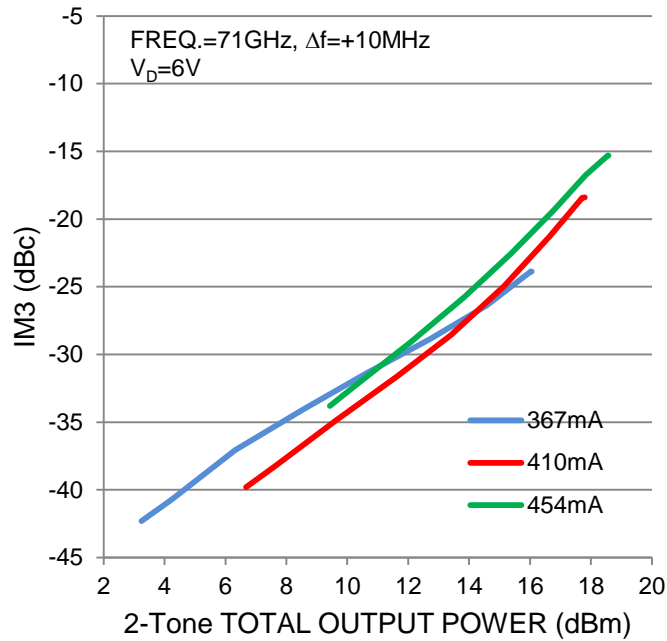

IM3 vs. Output Power by Temperature

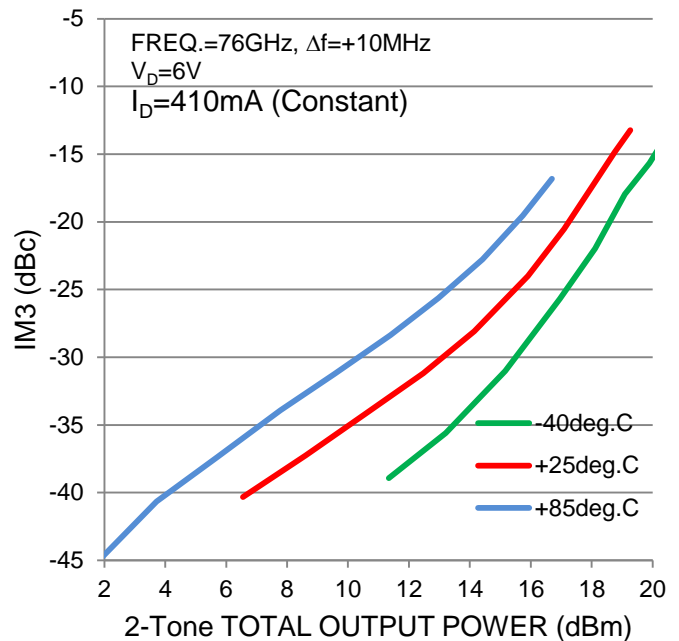
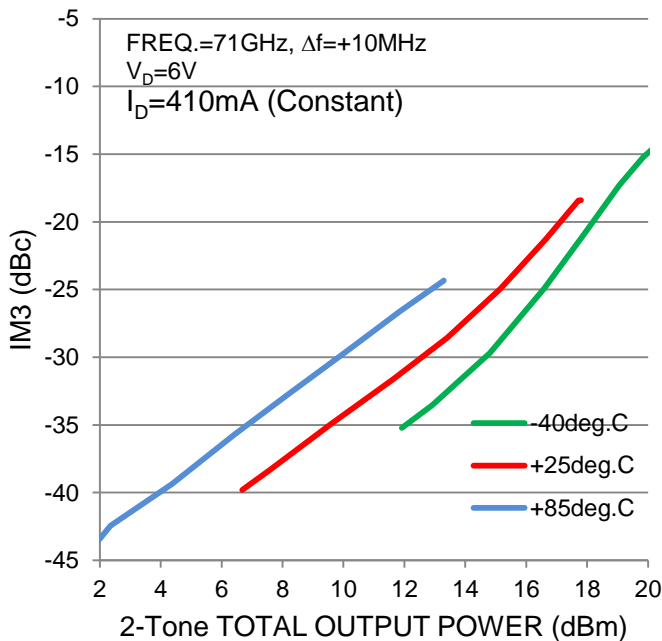
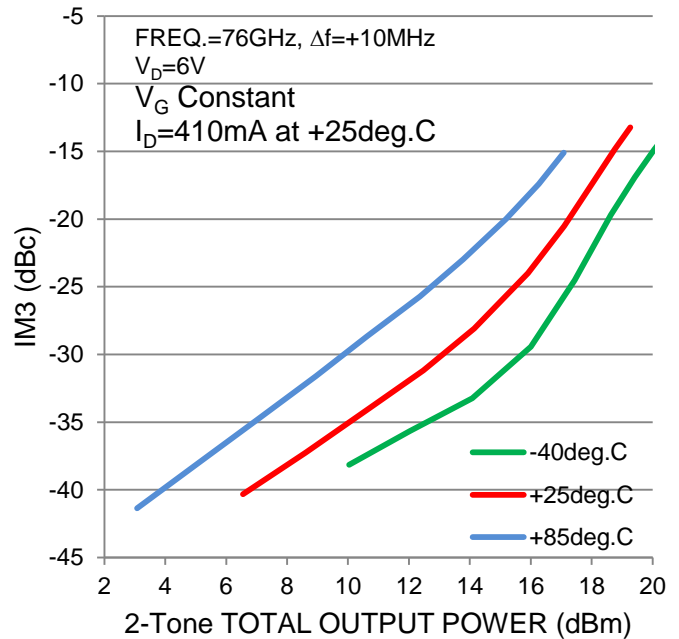
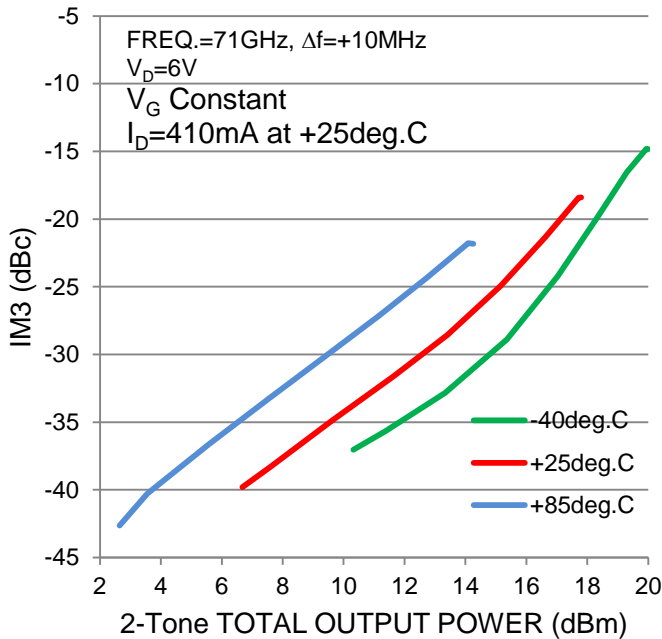

■ Pin Assignment

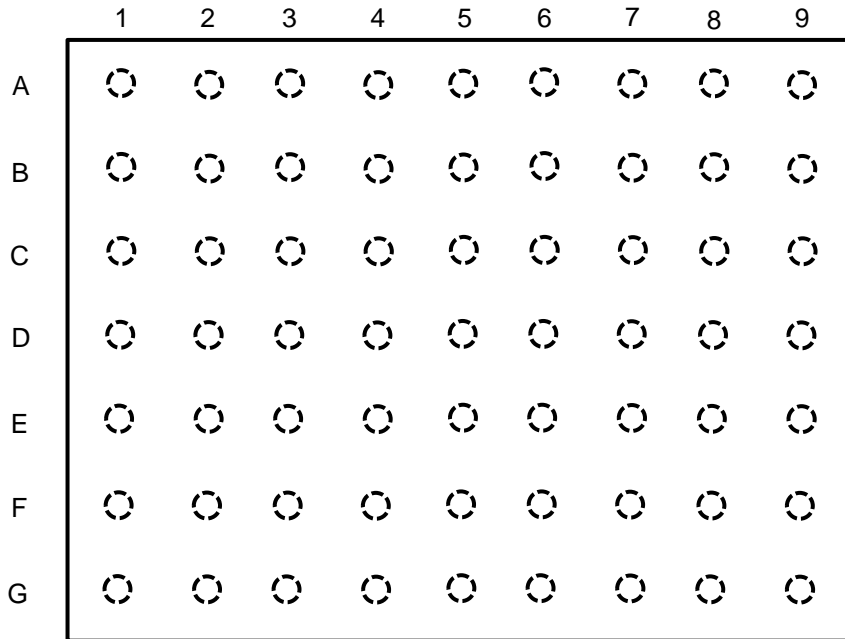

Bump Side Down (Die Top View)

Pin Assignment

	1	2	3	4	5	6	7	8	9
A	GND	GND	GND	GND	GND	GND	GND	GND	GND
B	RFin	GND	GND	GND	GND	GND	GND	GND	RFout
C	GND	GND	GND	GND	GND	GND	GND	GND	GND
D	GND	GND	GND	GND	GND	GND	GND	GND	GND
E	GND	GND	GND	GND	GND	GND	GND	GND	GND
F	GND	V _{D1}	V _{D2}	V _{D3}	V _{D3}	GND	GND	GND	GND
G	V _G	V _{D1}	V _{D2}	V _{D3}	V _{D3}	GND	GND	GND	GND

■ **Marking**

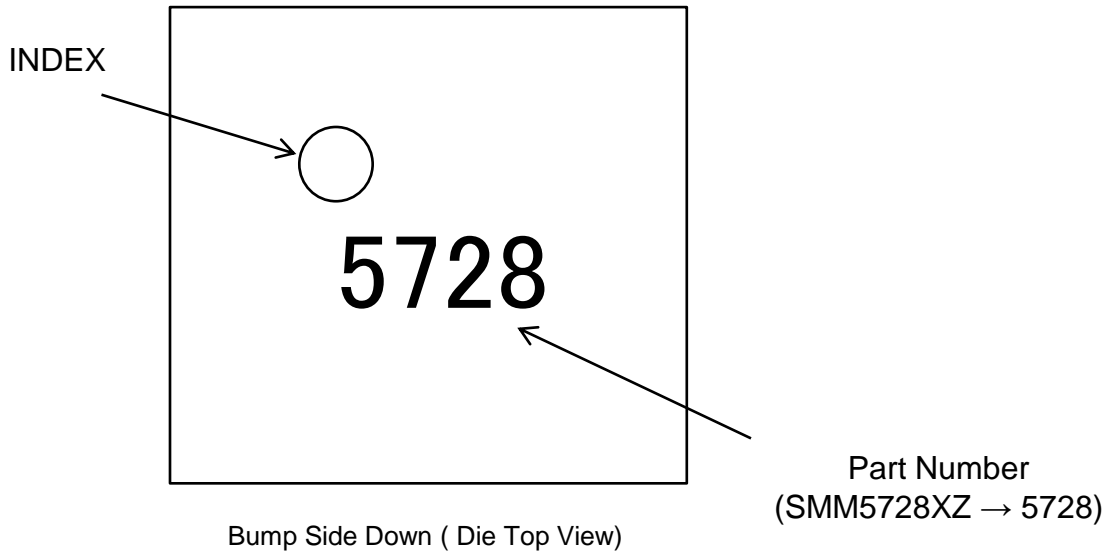

■ Typical Application

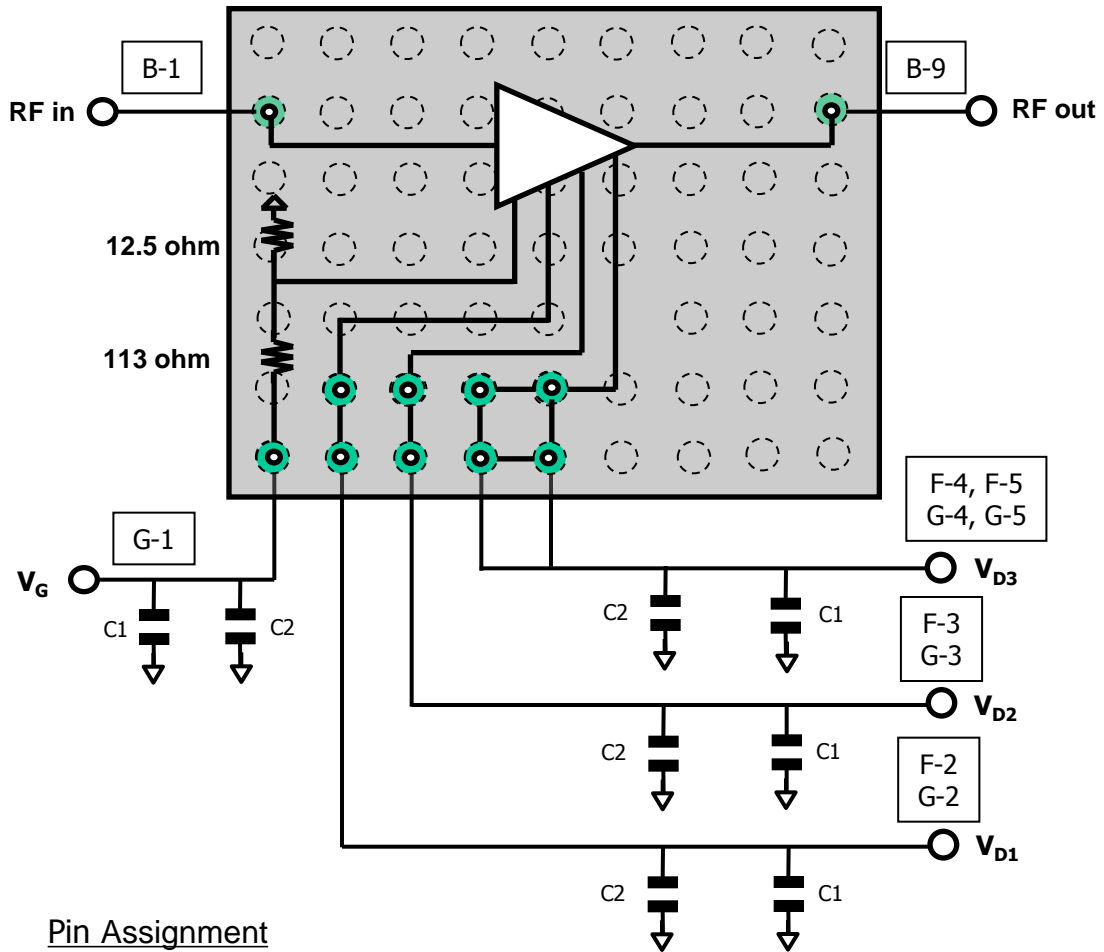

Pin Assignment

Pin	Name
B-1	RF Input
G-1	V_G
F-2, G-2	V_{D1}
F-3, G-3	V_{D2}
F-4, G-4 F-5, G-5	V_{D3}
B-9	RF Output

Component List

Name	Description	Value
C1	Capacitor	0.1uF
C2	Capacitor	100pF

■ PCB and Solder-resist Pattern

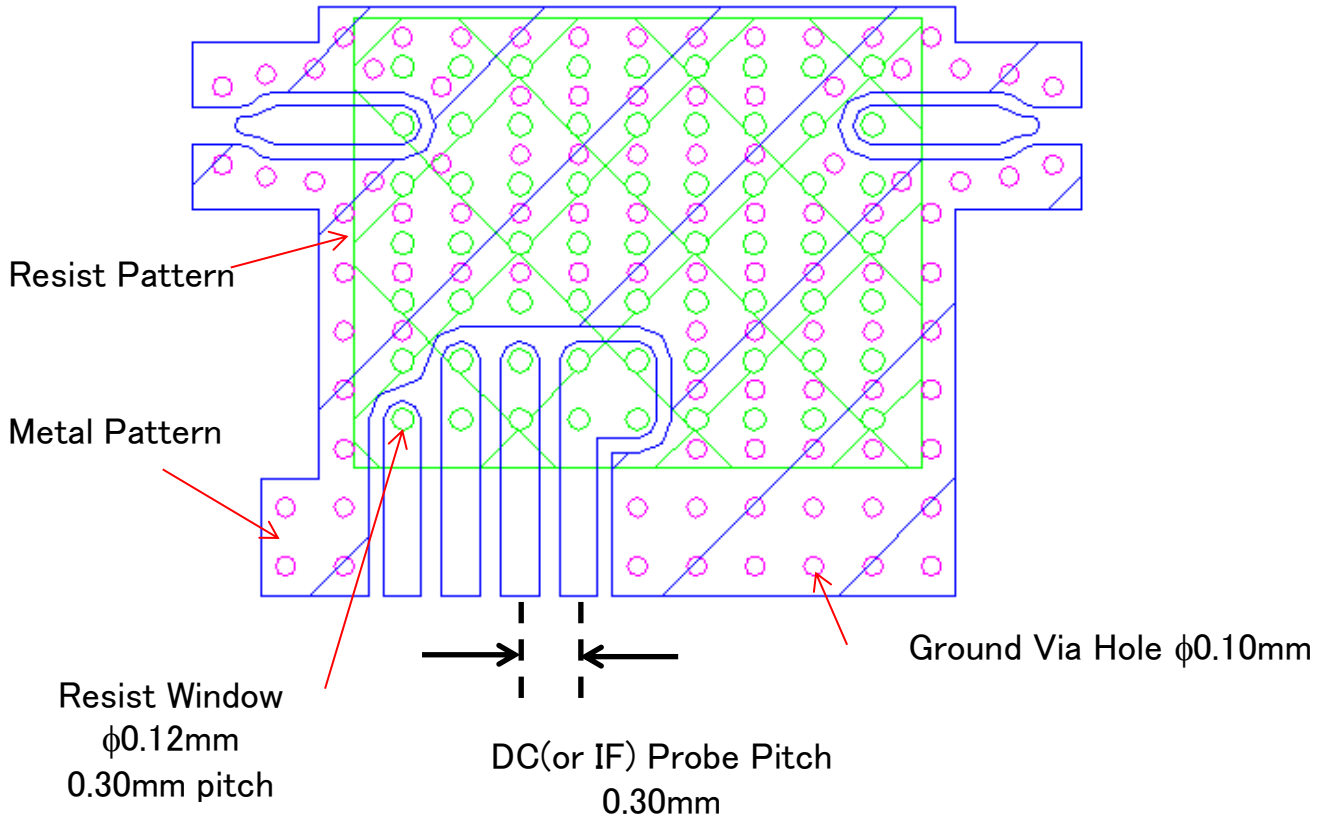

➤ Cross Section

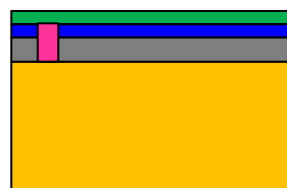

- Resist Pattern
maximum:0.020mm
- Metal Pattern
Cu/Ni/Au:0.030mm
- Core Material
Hitachi Chemical Co.
MCL-E-679F:0.10mm
- Base Metal
Cu:1.0mm

The long-term reliability of WLCSP is dependent on the channel temperature (T_{ch}) of FET, and the temperature of the under bump metal.

The temperature of the under bump metal is almost equivalent to the temperature at the solder ball joint (T_c).

The lifetime of an FET channel is indicated to 15-page, and the lifetime of the under bump metal is indicated to 16-page.

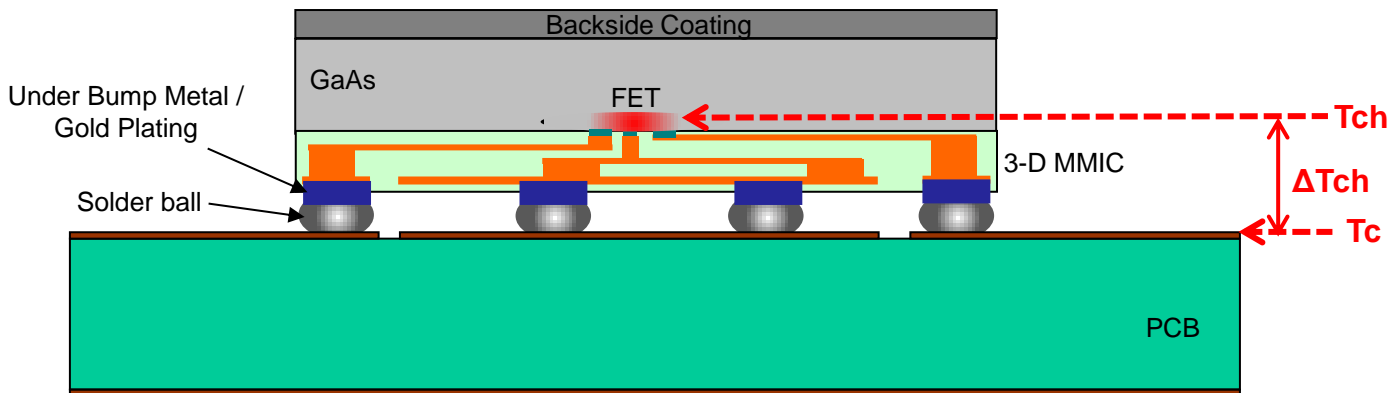

ΔT_{ch} vs. V_D Voltage

(Reference)

$I_D = 410\text{mA}$

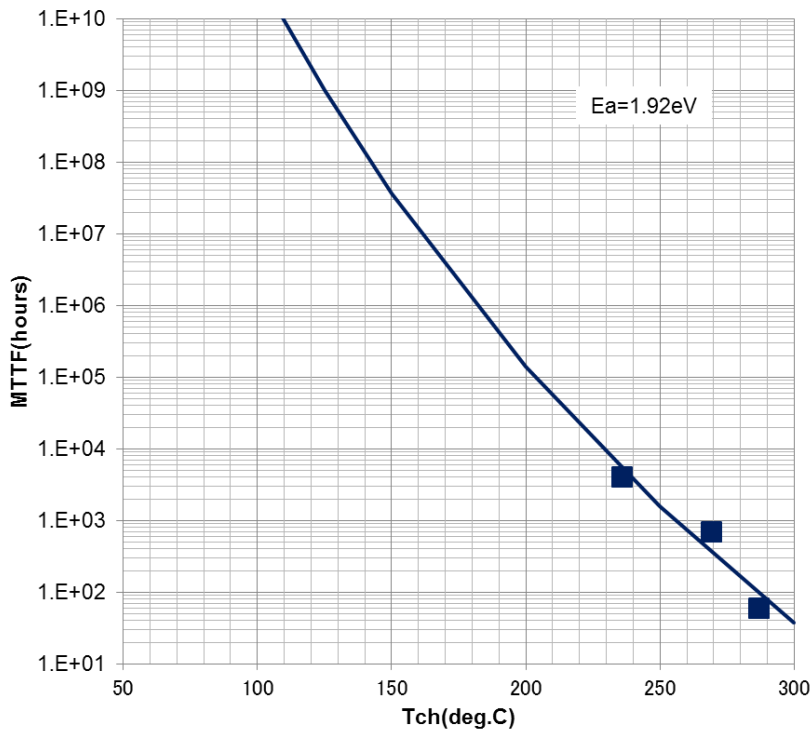
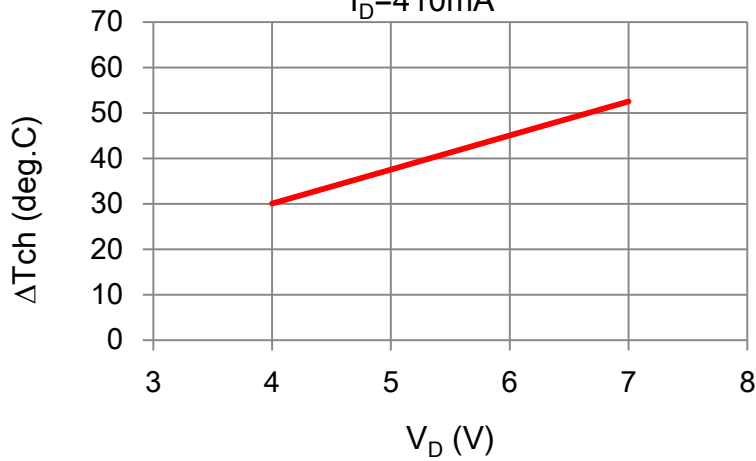

$$T_{ch} = T_c + \Delta T_{ch} \text{ (deg.C)}$$

T_c : Temperature at the solder ball Joint

The life time of the solder ball joint is dependent on temperature.

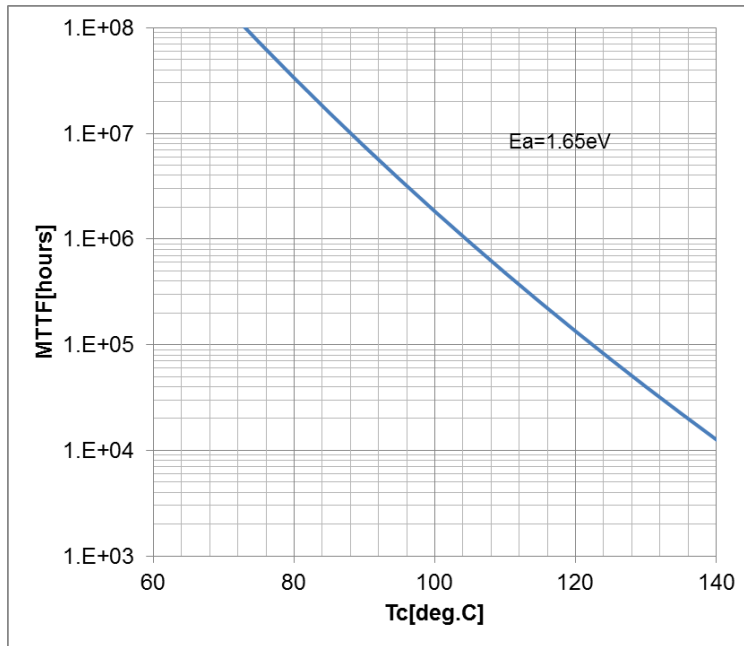

Tc : Temperature at the solder ball Joint

■ 2-inch Tray Packing (Part No. : SMM5728XZ)

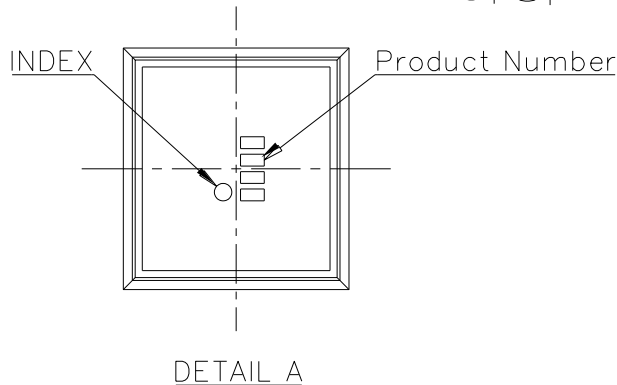
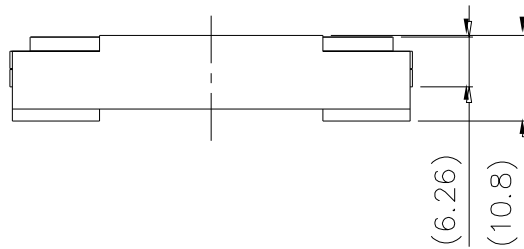
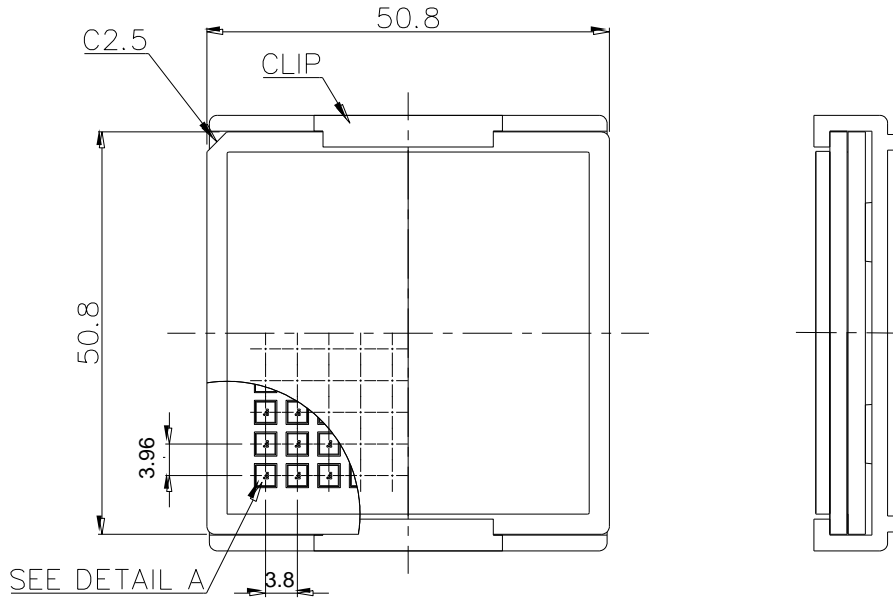

■ Tape and Reel Packing (Part No. : SMM5728XZT)

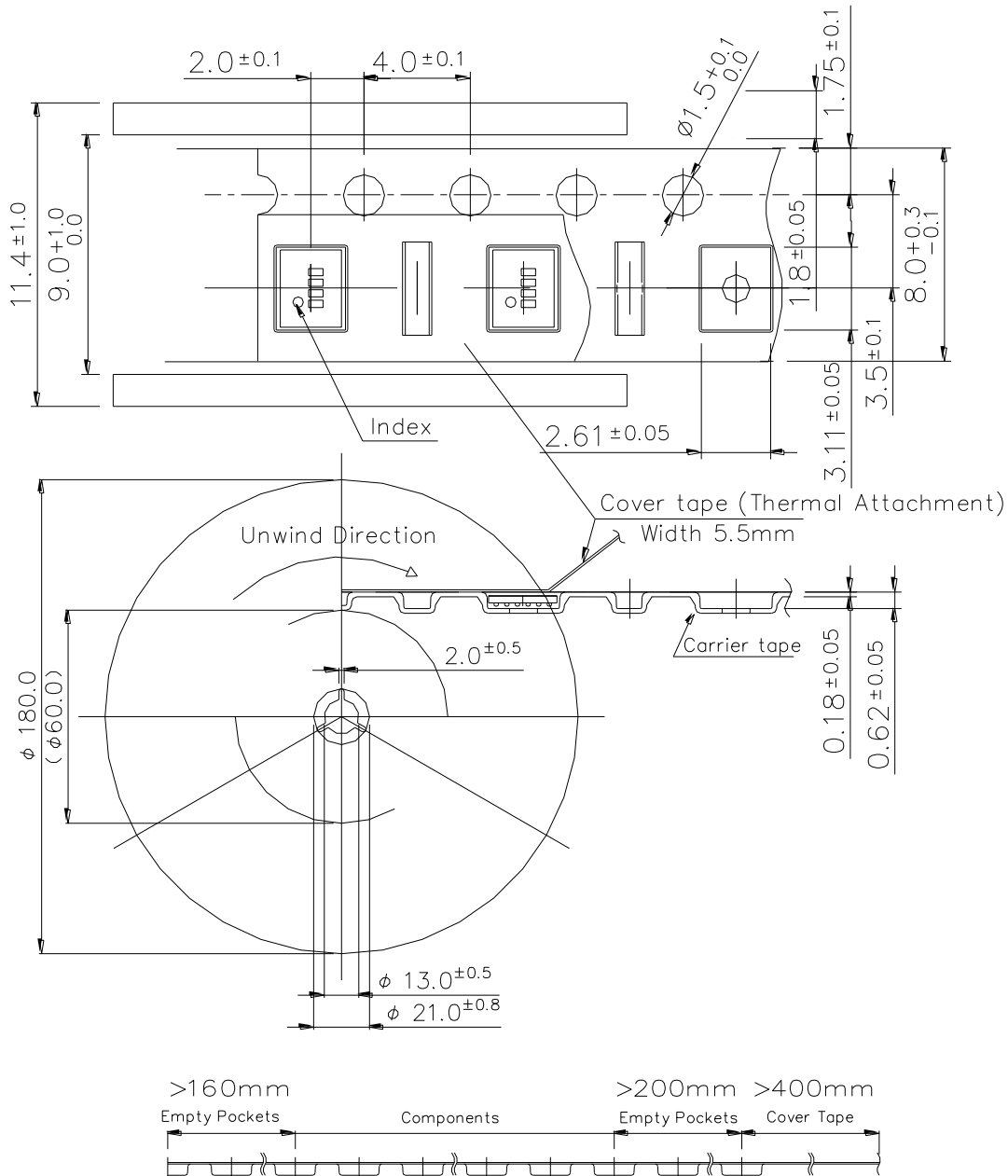

▷

■ Assembly Techniques for WLCSP MMICs

1. WLCSP Assembly Flow

WLCSP MMIC can be handled as a standard SMT component.

The following methods can be available, for example, C4 (Controlled Collapse Chip Connection) assembly techniques or a flux dip assembly method. In this case lower residue flux is recommended to save cleaning process steps, as liquid cleaning is not recommended.

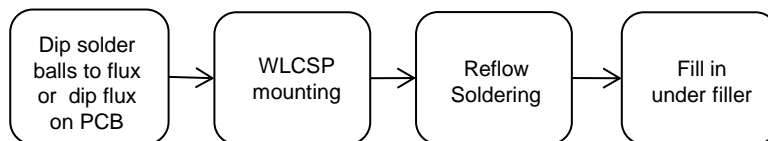

2. PCB Layout

PCB land patterns are based on SEI's experimental data. The land pattern has been developed and tested for optimized assembly at SEI. Solid-filled via is required to prevent depletion of the solder or solder paste and solder ball from ground pad through via holes during the reflow soldering process. To prevent shorts between solder balls, solder mask resist should be used. A recommended PCB layout is shown on page 13.

3. Die Mounting

For WLCSP MMIC with fine pitch of 0.3mm, it is recommended to use automated fine-pitch placement. Due to the variety of mounting machines and parameters and surface mount processes vary from company to company, careful process development is recommended.

■ Assembly Techniques for WLCSP MMICs

4. Reflow Soldering

The solder reflow condition (infrared reflow/heat circulation reflow/hotplate reflow) shall be optimized and verified by the customer within the condition shown in Figure 1 to realize optimum solder ability. An excessive reflow condition can degrade the WLCSP MMICs that may result in device failure. The solder reflow must be limited to three (3) cycles maximum. The temperature profile during reflow soldering shall be controlled as shown in Figure 1.

Customers must optimize and verify the reflow condition to meet their own mounting method using their own equipment and materials. For any special application, please contact the Sumitomo sales office nearest you for information.

Certain types of PCB expand and contract causing peaks and valleys in the board material during the reflow cycle. The recommended measure to prevent this from occurring is to screw the PCB onto a stiffener board with a small heat capacity prior to the reflow process.

The solder balls of WLCSP MMIC use Pb-free alloy and the melting point of the Sn/Ag/Cu used is 218deg.C The actual profile used depends on the thermal mass of the entire populated board and the solder compound used.

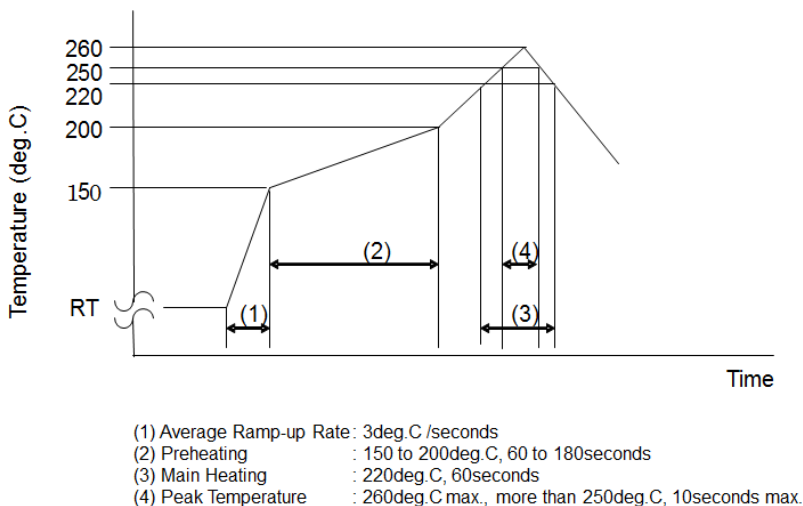

Figure 1

■ Assembly Techniques for WLCSP MMICs

5. Cleaning

SEDI does not recommend a liquid cleaning system to clean WLCSP MMIC. If a liquid cleaning system is required, please contact our nearest sales office from the list at <http://global-sei.com/Electro-optic/about/office.html>.

6. Underfill Process

WLCSP MMIC is connected to PCB by solder balls. A major concern in using WLCSP MMICs is the ability of the solder balls to withstand temperature cycling. It is thought the stress to the solder balls due to the difference of the coefficients of thermal expansion between GaAs and PCB is a potential cause of failure. To reduce this stress, it is recommended to use underfill in the gap between the WLCSP die and the PCB. In reliability tests, underfill has beneficial results in temperature cycle, drop test and mechanical stress test. The other side, underfill is undesirable due to the complexity of the process and added assembly cost from the additional process. The end user must decide to whether to use this process from their own test results.

7. Prevention of Static Electricity

Semiconductor devices are sensitive to static electricity.

These devices are attached the mark indicated sensitive to static electricity as shown to the right on the package (tray, taping, reel, etc.).

User must pay careful attention to the following precautions when handling semiconductor devices.

7-1. ESD Classification of Our Products

ESD class	0A
Breakdown Voltage	<125



Test method of ESD sensitivity: ANSI/ESDA/JEDEC JS-001-2012 (C=100 pF, R=1500 ohm)

7-2. Prevention of Static Electricity

7-2-1. Environment Conditions

User should control the relative humidity. If the relative humidity is low, semiconductor devices might breakdown by static electricity on electrification. It is more desirable that the relative humidity should control from 40 to 75%.

7-2-2. Work place

User should lay a conductive mat on the bench. When handling the products of ESD class 0A or 0B, user should lay a conductive mat on the floor. And, user should periodically check the resistance of conductive mat surface and grounding condition.

■ **Assembly Techniques for WLCSP MMICs**

7-2-3. Worker

Workers should wear a grounding wrist strap which is connected to a grounded anti-static work surface when handling the products. Especially when handling the products of ESD class 0A or 0B, workers should wear anti-static clothes and shoes. The wrist strap should be checked grounding condition periodically.

7-2-4. Equipment and Tool

- Equipment and tool handling the products should be connected to the ground.
- Part of equipment and tool contacting the products should be used conductive material(*1) and static dissipative material(*2) because static electricity is not charged them. Ideally any insulator should be eliminated from working environment. But there exist some in real cases. In this case, it is necessary to neutralize the electrification on the insulator material(*3).
- Please ground the tip of soldering iron.

[References]

(*1) Static dissipative material: Sheet resistance $\geq 1 \times 10^5 \text{ohm}$, $< 1 \times 10^{11} \text{ohm}$

(*2) Conductive material: Sheet resistance $\geq 1 \times 10^2 \text{ohm}$, $< 1 \times 10^5 \text{ohm}$

(*3) Insulator material: Sheet resistance $\geq 1 \times 10^{11} \text{ohm}$

(IEC 61340-5-1)

7-2-5. The others

- When the products are removed from the shipping container, user should not touch the device leads. When devices are kept, and transported, it is recommended to put them in anti-static bags or containers or racks with lid and to seal them.
- Before mounting the products in a circuit, the circuit connections should be shorted to the ground for setting static electricity free.

8. RoHS Compliance

RoHS Compliance	Yes
------------------------	------------

■ Assembly Techniques for WLCSP MMICs

9. Handling of WLCSP MMICs in Tape and Reel From

Peel the carrier tape and the top tape off slowly at a rate of 10 mm/s or less to prevent the generation of electro-static discharge. When peeling the tape off, the angle between the carrier tape and the top tape should be kept at 165 to 180 degrees as shown in Figure 2.

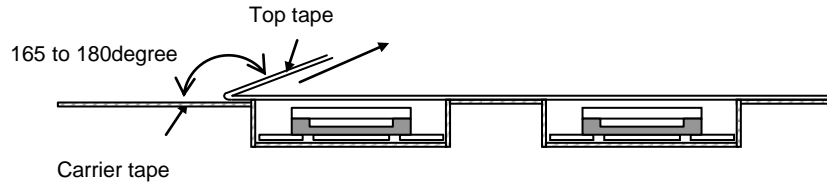

Figure 2

10. Packing

WLCSP products are offered in either the tape and reel or tray shipping configuration. The products are placed with solder bump facing down.

a) Tray Shipment

Each tray contains 100pcs. and minimum order is one tray, and must order in 100pcs. increment

b) Tape and Reel Shipment

Each reel contains 500pcs. and minimum order is one reel, and must order in 500pcs. increment

ORDERING INFORMATION

SMM5728XZ : Tray Shipment : 100pcs. /Tray and, 100pcs. (per Tray) increment.

SMM5728XZT : Tape and Reel Shipment : 500pcs. /Reel, and 500pcs. (per Reel) increment.

Part Number	Order Unit	Packing
SMM5728XZ	100pcs.	100pcs./Tray=100pcs./Packing
SMM5728XZT	500pcs.	500pcs./Reel=500pcs./Packing

- NOTE -

This information is described as reference information based on SEI experimental test like assembly process, PCB and stencil design, Temperature cycle test result and so on.

SEI can not guarantee the quality of WLCSP after the customer's assembly process because assembly and PCB condition is generally different between customer and SEI.

Please check the quality of device (or system) after customer assembles with customer's PCB and assembly process.

■ BARE DIE INDEMNIFICATION

All devices are DC probed and visually inspected at SEI, and non-compliant devices are removed. The RF electrical characteristics of the bare dice are warranted by the sampling inspection procedures. The standard sampling inspection procedure shall include the number of the sampling dice, position of the sampling dice in the wafer and RF electrical characteristics of the sampling dice measured in the test fixture. Customer shall understand that all the bare dice will not be 100% RF tested by SEI. It is the customer responsibility to verify performance of the devices.

Customer shall comply with the storage and handling requirements for condition and period of storage of the bare dice agreed by customer and SEI. Warranty will not apply when customer disregards the storage and handling requirements.

Warranty will not apply to the electrical characteristics and product quality to the bare dice after assembly by customer.

SEI will indemnify customer for warranty failures, provided however that the indemnification to customer shall be limited to supply of bare dice for substitution.

For further information please contact:

<http://global-sei.com/Electro-optic/about/office.html>

CAUTION

Sumitomo Electric Device Innovations, Inc. products contain **gallium arsenide (GaAs)** which can be hazardous to the human body and the environment. For safety, observe the following procedures:

- Do not put these products into the mouth.
- Do not alter the form of this product into a gas, powder, or liquid through burning, crushing, or chemical processing as these by-products are dangerous to the human body if inhaled, ingested, or swallowed.
- Observe government laws and company regulations when discarding this product. This product must be discarded in accordance with methods specified by applicable hazardous waste procedures.