

FEATURES

- Wafer Level Chip Scale Package with Solder Ball
- Integrated Balanced Mixer, LO Buffer Amplifier and x2 multiplier
- Conversion Gain : -12dB
- Input Third Order Intercept (IIP3) : +22dBm
- 2LO-RF Isolation : 45dB
- +10dBm LO Drive Level

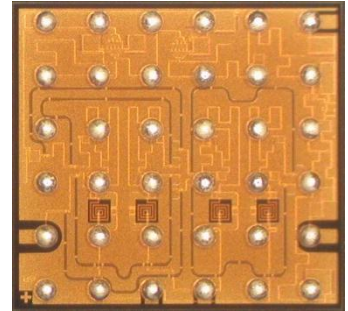

DESCRIPTION

The SMM5145XZ is a double balanced up converter MMIC for applications in the 12.7 to 15.4GHz frequency range. The device consists of a balanced resistive PHEMT mixer, LO amplifier and x2 multiplier in a flip chip form. The flip chip die can be used in solder reflow process. Sumitomo Electric Device Innovations's stringent Quality Assurance Program assures the highest reliability and consistent performance.

ABSOLUTE MAXIMUM RATING

Item	Symbol	Rating	Unit
Drain Voltage	V_{DD}	6	V
Input IF Power	$P_{in_{IF}}$	5	dBm
Input LO Power	$P_{in_{LO}}$	15	dBm
Storage Temperature	T_{stg}	-40 to +125	deg.C

RECOMMENDED OPERATING CONDITIONS

Item	Symbol	Conditions	Unit
Drain Voltage	V_{DD}	5	V
Input LO Power	$P_{in_{LO}}$	+10	dBm
Operating Case Temperature	T_c	-40 to +85	deg.C

ELECTRICAL CHARACTERISTICS (Case Temperature $T_c=25\text{deg.C}$)

Item	Symbol	Test Conditions	Limits			Unit
			Min.	Typ.	Max.	
RF Frequency Range	f_{RF}	$V_{DD}=5V$ $IF=1000MHz *1$	12.7		15.4	GHz
IF Frequency Range	f_{IF}		DC		2.0	GHz
LO Frequency Range	f_{LO}		5.3		8.7	GHz
LO Input Power	$P_{in_{LO}}$		---	10	---	dBm
Conversion Gain	G_c		-15	-12	-9	dB
Input 3rd.Order Intercept Point	IIP3		---	22	---	dBm
RF Return Loss	RL_{RF}		---	10	---	dB
IF Return Loss	RL_{IF}		---	10	---	dB
LO Return Loss	RL_{LO}		---	10	---	dB
LO-RF Isolation	ISO_{LO-RF}		---	30	---	dB
LO-IF Isolation	ISO_{LO-IF}	---	50	---	dB	
RF-IF Isolation	ISO_{RF-IF}	---	50	---	dB	
Current consumption	I_{DD}			60	100	mA

*1Unless otherwise noted all measurements performed with IF = 1GHz and external IF Balun.

LSB CONVERSION GAIN vs. FREQUENCY by LO input power

@ $F_{IF}=1\text{GHz}$, $P_{IF}=0\text{dBm}$, $VDD_{LOA}=5\text{V}$

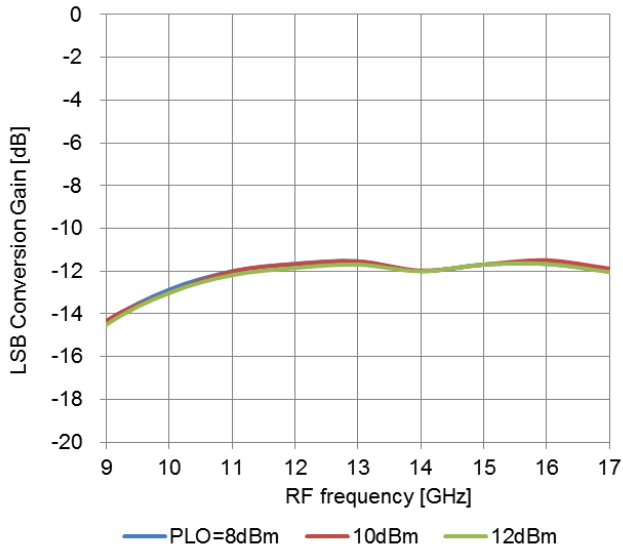

USB CONVERSION GAIN vs. FREQUENCY by LO input power

@ $F_{IF}=1\text{GHz}$, $P_{IF}=0\text{dBm}$, $VDD_{LOA}=5\text{V}$

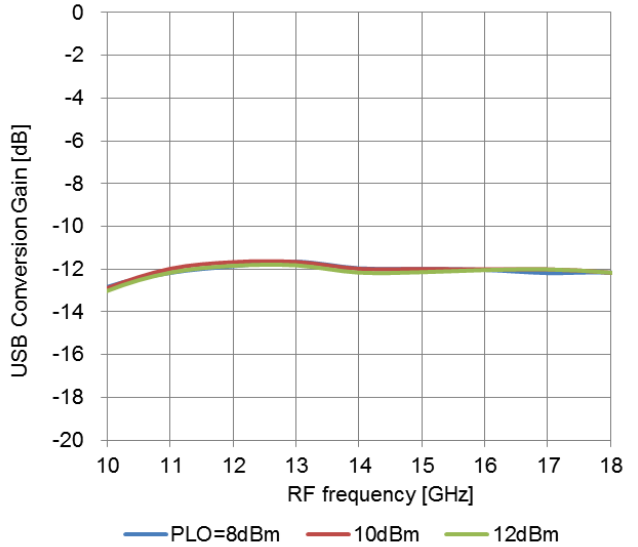

LSB IIP3 vs. FREQUENCY by LO input power

@ $F_{IF}=1\text{GHz}$, $P_{IF}=0\text{dBm}$, $VDD_{LOA}=5\text{V}$

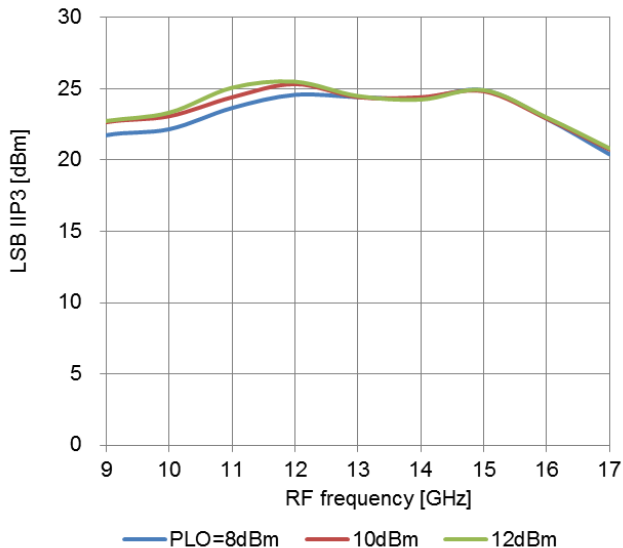

USB IIP3 vs. FREQUENCY by LO input power

@ $F_{IF}=1\text{GHz}$, $P_{IF}=0\text{dBm}$, $VDD_{LOA}=5\text{V}$

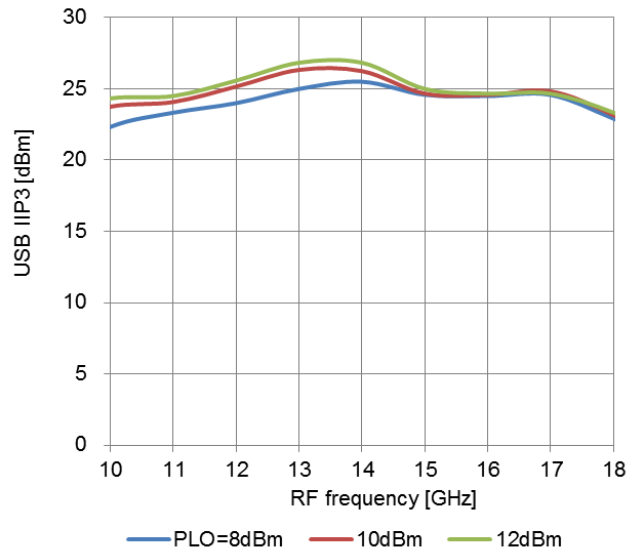

LO LEAKAGE vs. FREQUENCY by LO input power

@ $F_{IF}=1\text{GHz}$, $P_{IF}=0\text{dBm}$, $V_{DD_{LOA}}=5\text{V}$

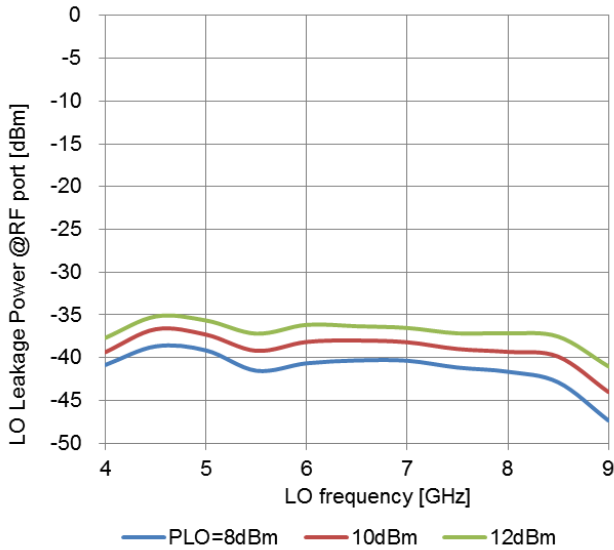

2x LO LEAKAGE vs. FREQUENCY by LO input power

@ $F_{IF}=1\text{GHz}$, $P_{IF}=0\text{dBm}$, $V_{DD_{LOA}}=5\text{V}$

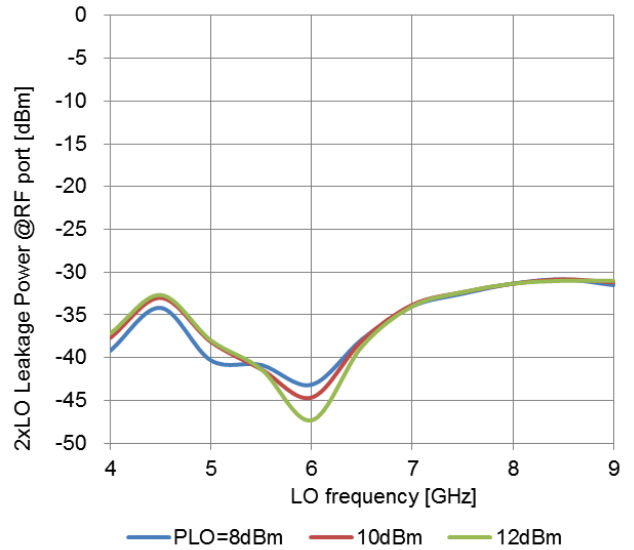

CURRENT CONSUMPTION vs. FREQUENCY

@ $F_{IF}=1\text{GHz}$, $P_{IF}=0\text{dBm}$, $V_{DD_{LOA}}=5\text{V}$

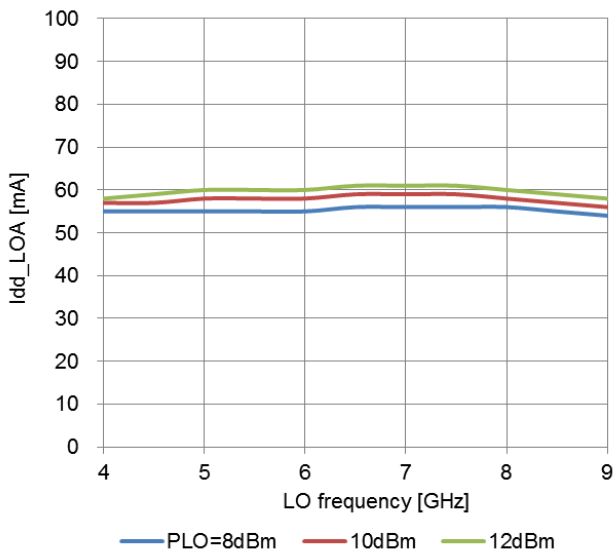

**LSB CONVERSION GAIN vs. FREQUENCY
by Temperature**

@ $F_{IF}=1\text{GHz}$, $P_{IF}=0\text{dBm}$, $P_{LO}=10\text{dBm}$, $VDD_{LOA}=5\text{V}$

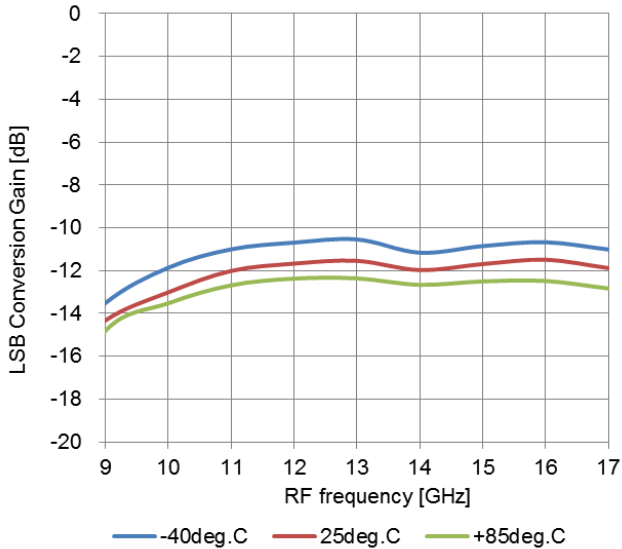

**USB CONVERSION GAIN vs. FREQUENCY
by Temperature**

@ $F_{IF}=1\text{GHz}$, $P_{IF}=0\text{dBm}$, $P_{LO}=10\text{dBm}$, $VDD_{LOA}=5\text{V}$

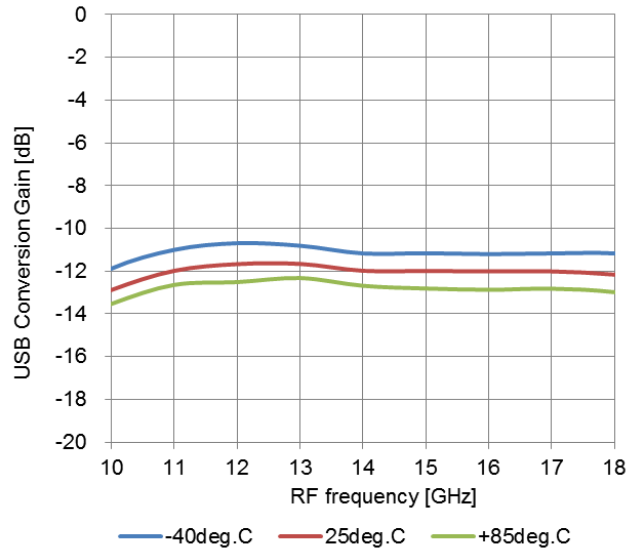

**LSB IIP3 vs. FREQUENCY
by Temperature**

@ $F_{IF}=1\text{GHz}$, $P_{IF}=0\text{dBm}$, $P_{LO}=10\text{dBm}$, $VDD_{LOA}=5\text{V}$

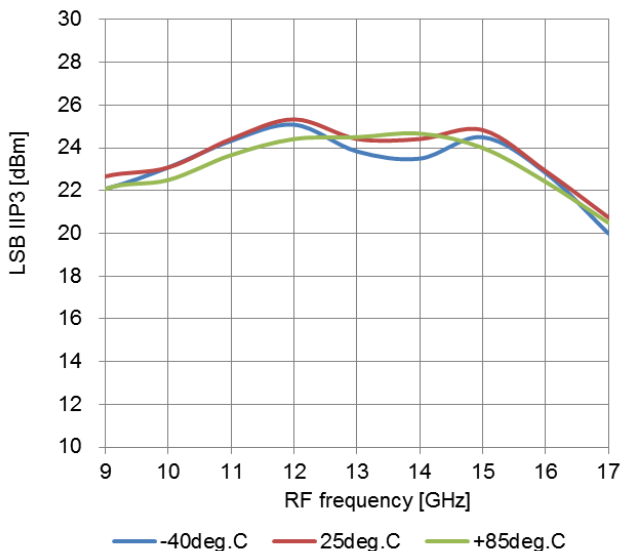

**USB IIP3 vs. FREQUENCY
by Temperature**

@ $F_{IF}=1\text{GHz}$, $P_{IF}=0\text{dBm}$, $P_{LO}=10\text{dBm}$, $VDD_{LOA}=5\text{V}$

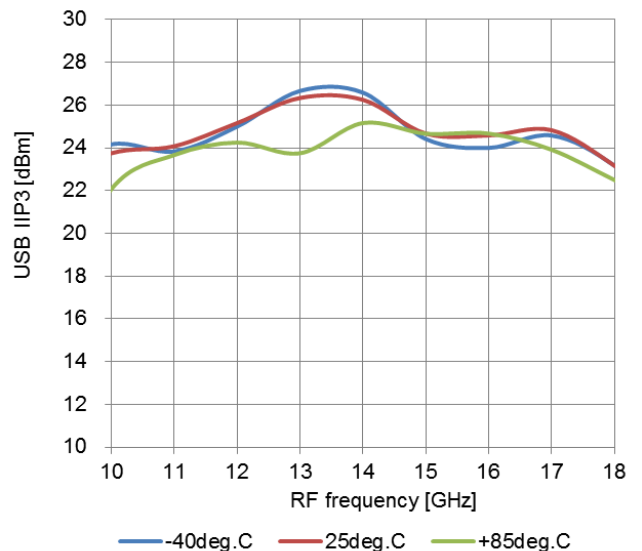

LO LEAKAGE vs. FREQUENCY by Temperature

@ $F_{IF}=1\text{GHz}$, $P_{IF}=0\text{dBm}$, $P_{LO}=10\text{dBm}$, $VDD_{LOA}=5\text{V}$

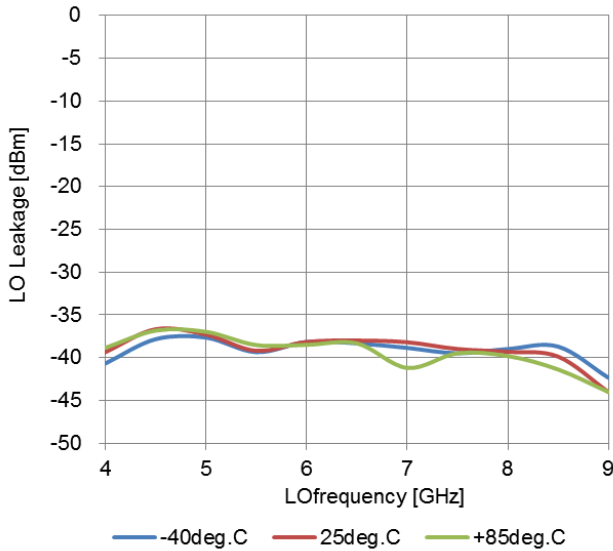

2x LO LEAKAGE vs. FREQUENCY by Temperature

@ $F_{IF}=1\text{GHz}$, $P_{IF}=0\text{dBm}$, $P_{LO}=10\text{dBm}$, $VDD_{LOA}=5\text{V}$

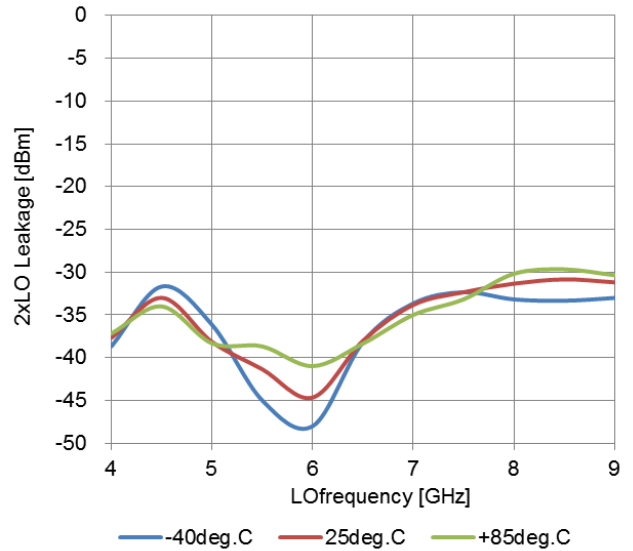

CURRENT CONSUMPTION vs. FREQUENCY by Temperature

@ $F_{IF}=1\text{GHz}$, $P_{IF}=0\text{dBm}$, $P_{LO}=10\text{dBm}$, $VDD_{LOA}=5\text{V}$

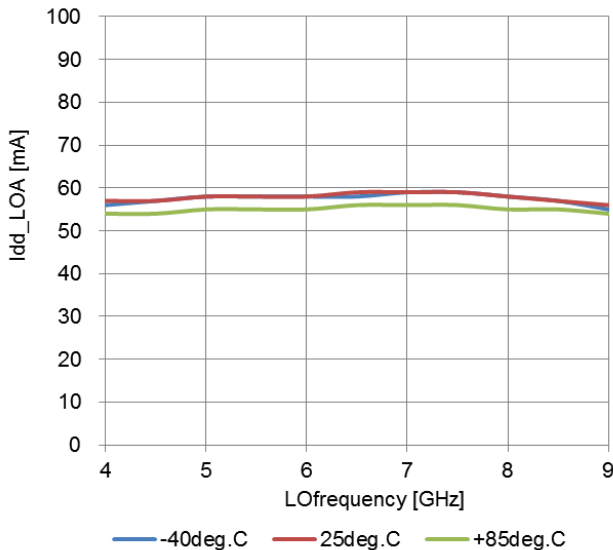

RETURN LOSS at RFport

@ VDD_{LOA}=5V

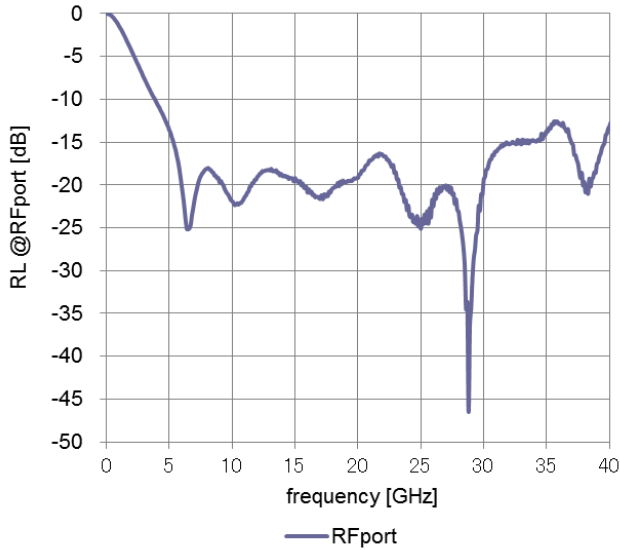

RETURN LOSS at LOport

@ VDD_{LOA}=5V

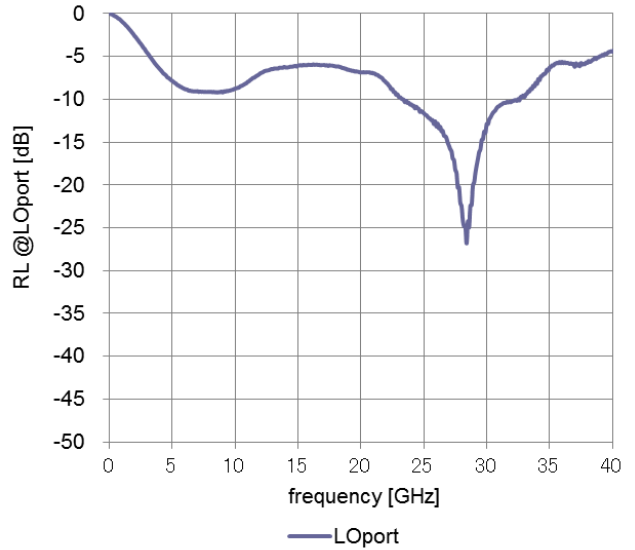

RETURN LOSS at IFport

@ VDD_{LOA}=5V

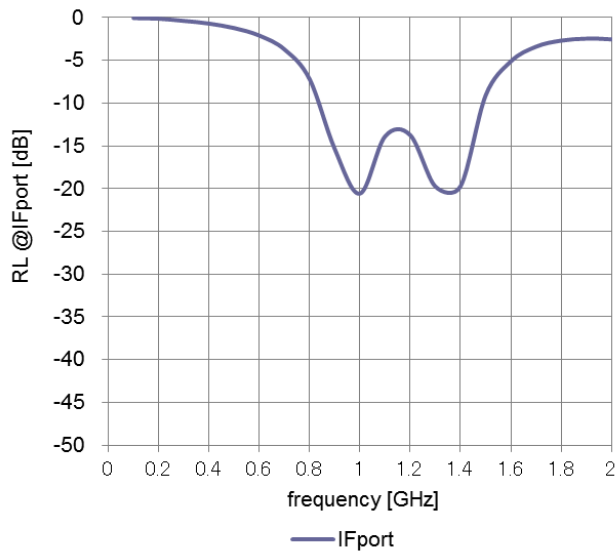

Return loss at IF port was measured with external Balun (LDB21942M10C-001)

■ Chip outline

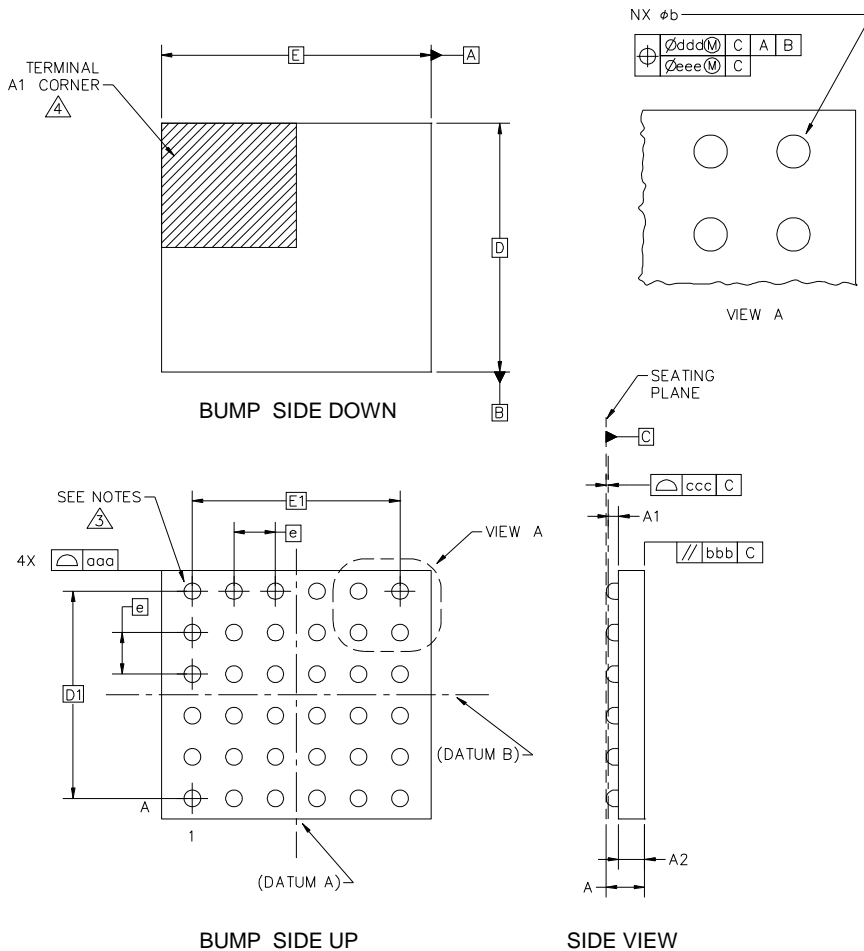

Symbol	Dimensions (typ.)	Note
A	0.396	
A1	0.121	
A2	0.275	
b	0.168	
D	2.37	
D1	2.00	
E	2.57	
E1	2.00	
e	0.40	
MD	6	
ME	6	
N	36	
aaa	0.07	
bbb	0.046	
ccc	0.03	
ddd	0.07	
eee	0.03	

NOTES :

1. DIMENSIONING AND TOLERANCING PER ASME Y14.5M-1994
2. ALL DIMENSIONS ARE IN MILLIMETERS
3. $\triangle 3$ BALL DESIGNATION PER JEDEC STD MS-028 AND JEP95
4. $\triangle 4$ DETAILS OF PIN #1 IDENTIFIER ARE OPTIONAL, BUT MUST BE LOCATED WITHIN THE ZONE INDICATED.
5. PRIMARY DATUM C IS SEATING PLANE
6. ALLOY OF SOLDER BALL : Sn-3.0Ag-0.5Cu

■ Pin Assignment

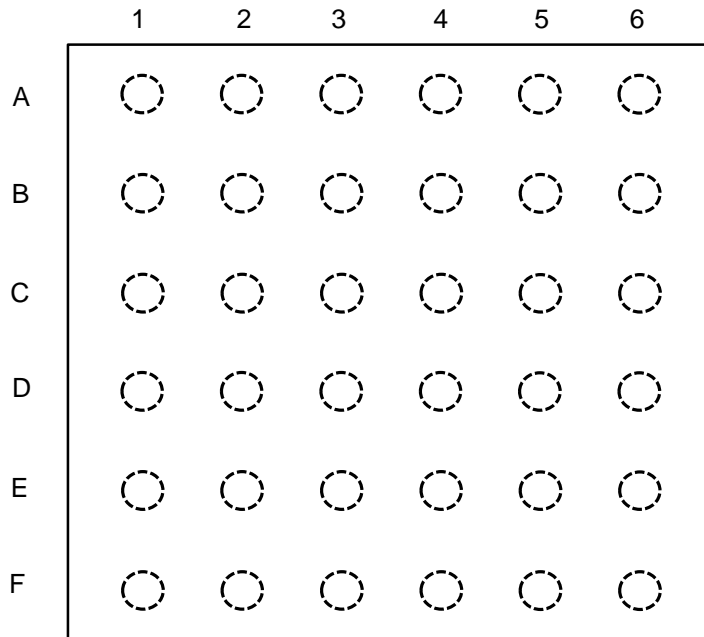

Bump Side Down (Die Top View)

Pin Assignment

	1	2	3	4	5	6
A	VDD	GND	GND	GND	GND	GND
B	GND	GND	GND	GND	GND	GND
C	GND	GND	GND	GND	GND	GND
D	GND	GND	GND	GND	GND	GND
E	LOIN	GND	GND	GND	GND	RFOUT
F	GND	GND	IFIN(I)	IFIN(Q)	GND	GND

■ Application Circuit Block Diagram

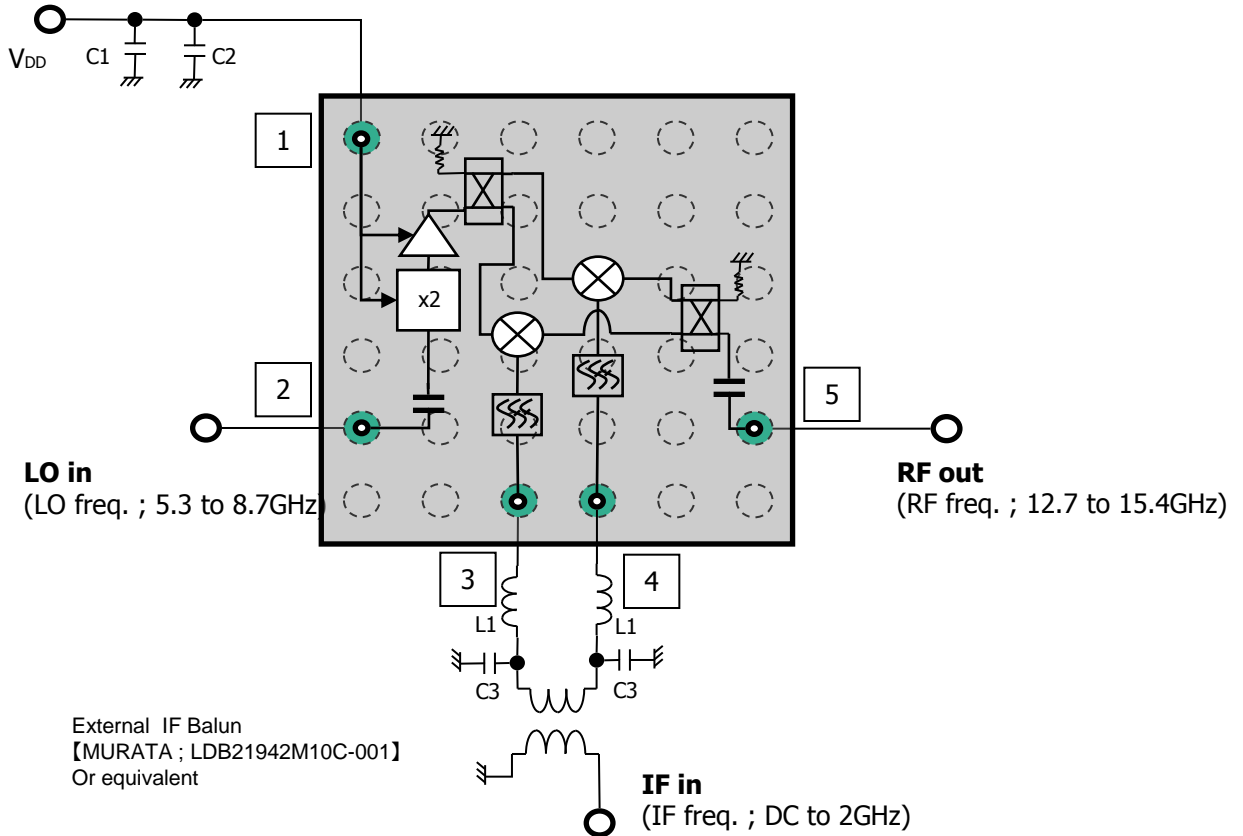

Pin Assignment

Pin	Name
1	VDD
2	LO Input
3, 4	IF Input
5	RF Output

*All bumps except Pin 1 to 5 are GND

Component List

Name	Description	Value
C1	Capacitor	0.1uF
C2	Capacitor	1000pF
C3*1	Capacitor	3.3pF
L1*1	Inductor	3.9nH

*1 : External matching circuit for $f_{IF}=1\text{GHz}$

■ Marking

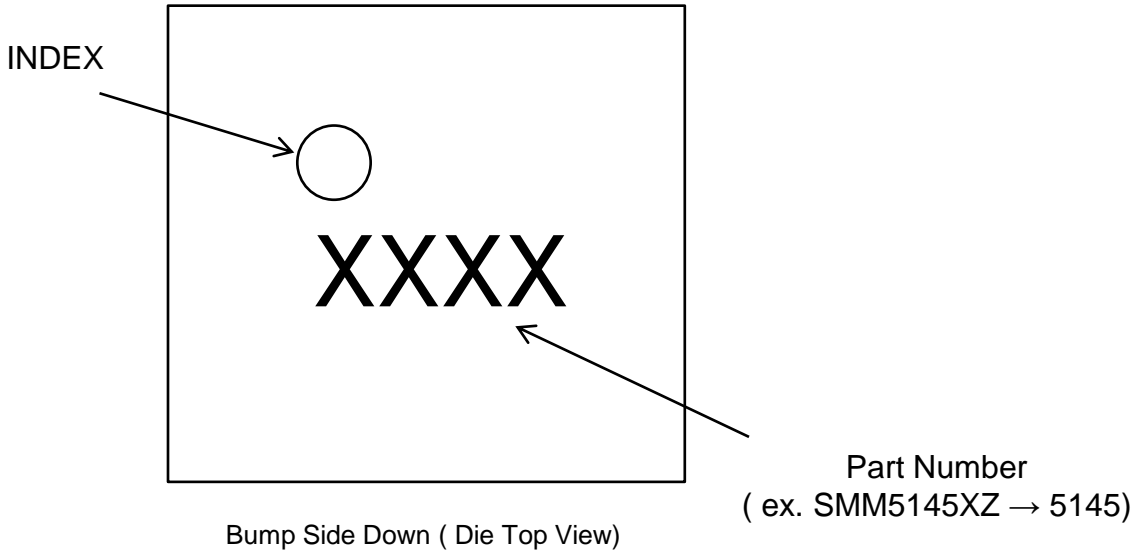

■ PCB and Solder-resist Pattern

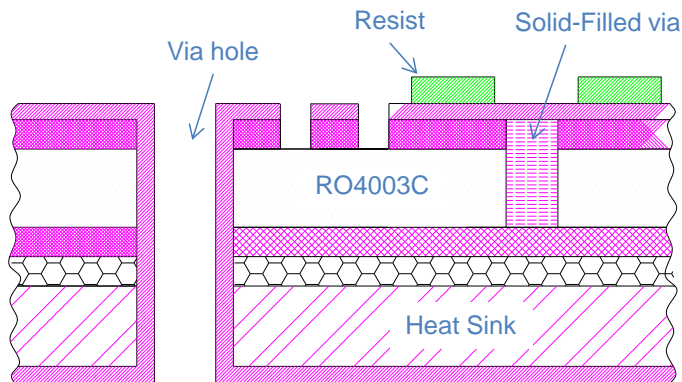
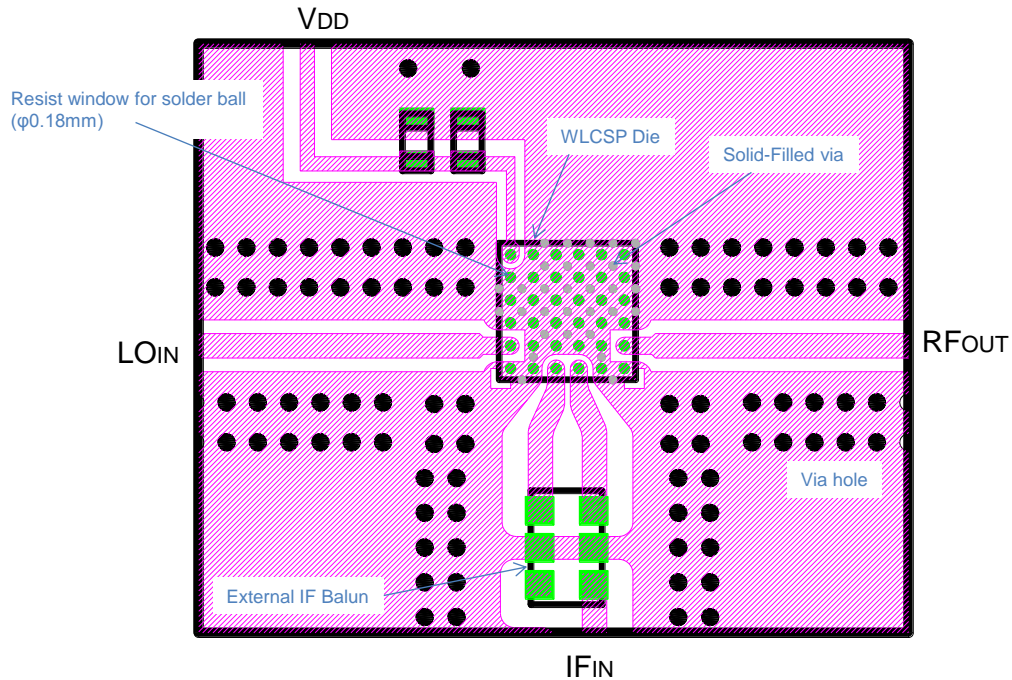

NOTES.

- 1) Core Material ; Rogers CORP. 4003
Thickness 0.2mm typ. , Er=3.38 typ.
- 2) Copper Foil Thickness ; 18um typ.
- 3) Finish Copper Foil ; Ni 1um min. / Au 0.1um max.
- 4) Resist ; +/- 20um.
- 5) All Dimensions are in mm.
- 6) Solid-filled via is used to prevent depletion of the solder from ground pad through via holes

■ 2-inch Tray Packing (Part No. : SMM5145XZ)

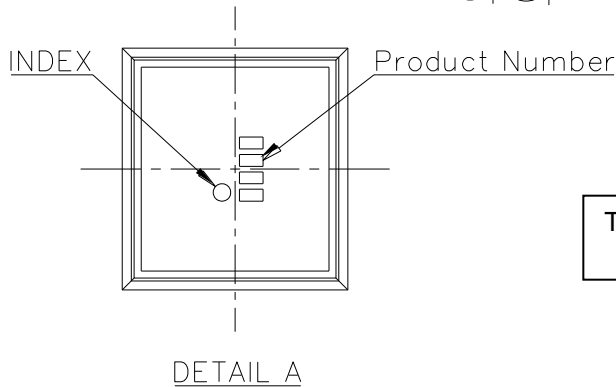
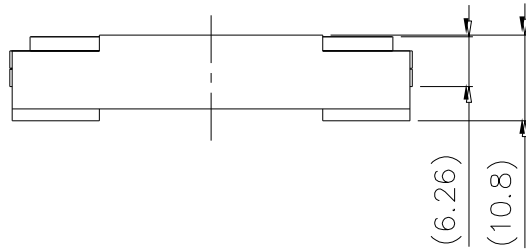
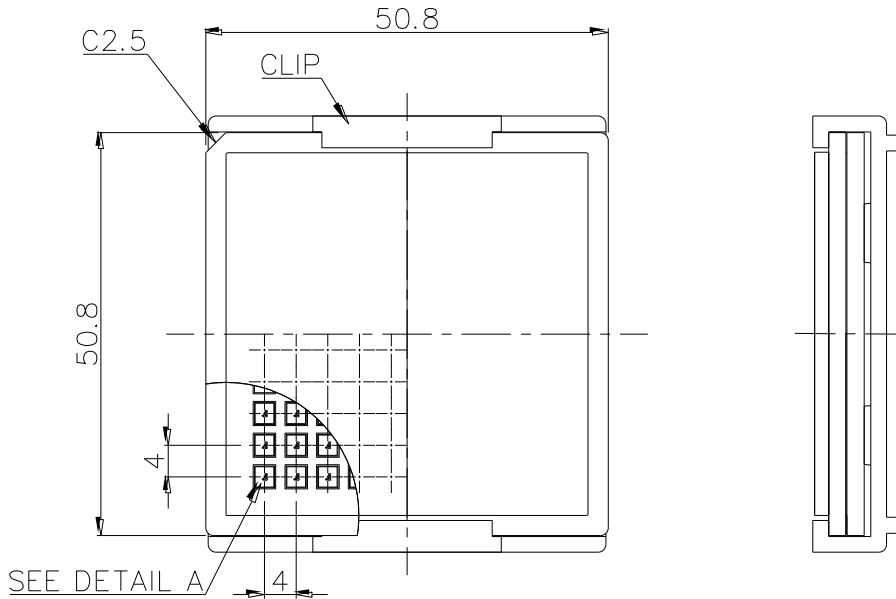

Tray Material : ABS – TP10
Quantity : 100 pcs. / Tray

■ Tape and Reel Packing (Part No. : SMM5145XZT)

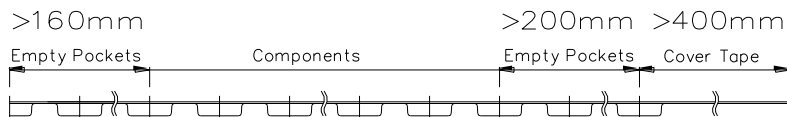
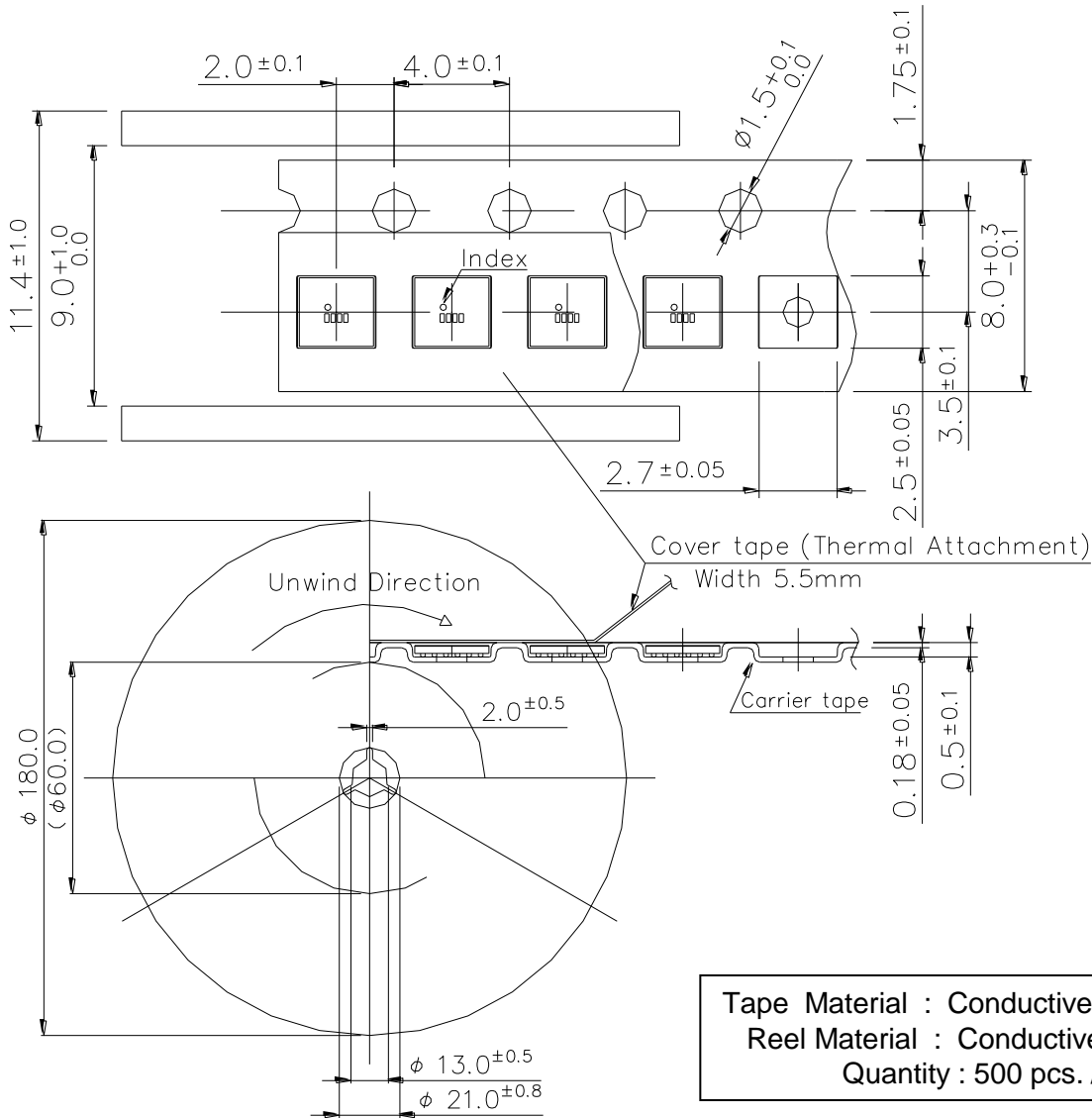

■ Assembly Techniques for WLCSP MMICs

1. WLCSP Assembly Flow

WLCSP MMIC can be handled as a standard SMT component as in the following assembly flow.

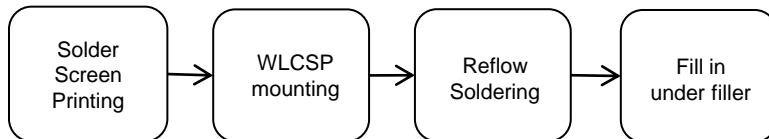

One can also make use of C4 (Controlled Collapse Chip Connection) assembly techniques or a flux dip assembly method. In this case lower residue flux is recommended to save cleaning process steps, as liquid cleaning is not recommended.

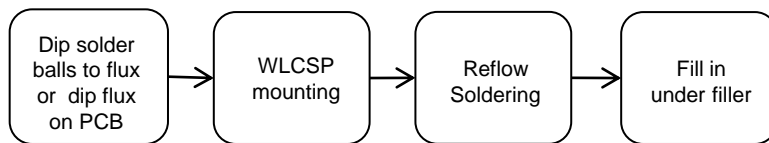

2. PCB Layout

PCB land patterns are based on SEI's experimental data. The land pattern has been developed and tested for optimized assembly at SEI. Solid-filled via is required to prevent depletion of the solder of solder paste and solder ball from ground pad through via holes during the reflow soldering process. To prevent shorts between solder balls, solder mask resist should be used. A recommended PCB layout is shown on page 11.

3. Stencil Mask

The use of solder mask is required to put WLCSP MMIC on PCB using standard SMT assembly techniques. The stencil mask design is critical. A minimum solder mask space of 0.16mm between solder balls must be used to prevent shorting. To realize stable solder volume, stencil thickness and opening need to be optimized. A recommended stencil mask pattern is shown in Fig. 1.

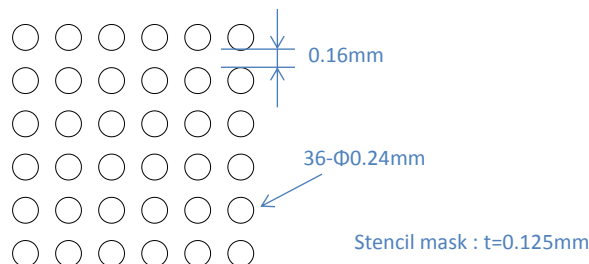

Figure 1

■ Assembly Techniques for WLCSP MMICs

4. Die Mounting

For WLCSP MMIC with fine pitch of 0.4mm, it is recommended to use automated fine-pitch placement. Due to the variety of mounting machines and parameters and surface mount processes vary from company to company, careful process development is recommended.

5. Reflow Soldering

The solder reflow condition (infrared reflow/heat circulation reflow/hotplate reflow) shall be optimized and verified by the customer within the condition shown in Fig.2 to realize optimum solder ability. An excessive reflow condition can degrade the WLCSP MMICs that may result in device failure. The solder reflow must be limited to three (3) cycles maximum. The temperature profile during reflow soldering shall be controlled as shown in Fig.2.

Customers must optimize and verify the reflow condition to meet their own mounting method using their own equipment and materials. For any special application, please contact the Sumitomo sales office nearest you for information.

Certain types of PCB expand and contract causing peaks and valleys in the board material during the reflow cycle. The recommended measure to prevent this from occurring is to screw the PCB onto a stiffener board with a small heat capacity prior to the reflow process.

The solder balls of WLCSP MMIC use Pb-free alloy and the melting point of the Sn/Ag/Cu used is 218deg.C The actual profile used depends on the thermal mass of the entire populated board and the solder compound used.

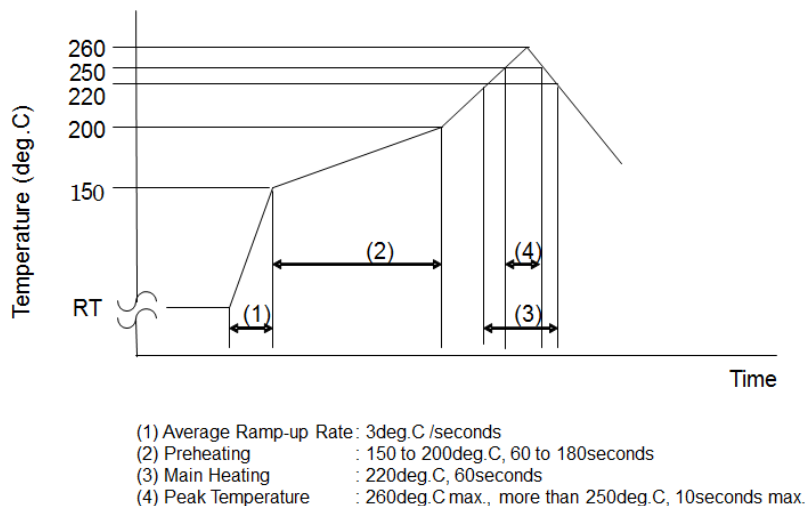

Figure 2

■ Assembly Techniques for WLCSP MMICs

6. Cleaning

SEDI does not recommend a liquid cleaning system to clean WLCSP MMIC. If a liquid cleaning system is required, please contact our nearest sales office from the list at <http://global-sei.com/Electro-optic/about/office.html>.

7. Underfill Process

WLCSP MMIC is connected to PCB by solder balls. A major concern in using WLCSP MMICs is the ability of the solder balls to withstand temperature cycling. It is thought the stress to the solder balls due to the difference of the coefficients of thermal expansion between GaAs and PCB is a potential cause of failure. To reduce this stress, it is recommended to use underfill in the gap between the WLCSP die and the PCB. In reliability tests, underfill has beneficial results in temperature cycle, drop test and mechanical stress test. The other side, underfill is undesirable due to the complexity of the process and added assembly cost from the additional process. The end user must decide to whether to use this process from their own test results.

8. ESD Protection

Semiconductor devices are sensitive to static electricity. User must pay careful attention to the following precautions when handling semiconductor devices.

Customers should lay a conductive mat on the bench, and use wrist ground straps.

When handling products with an ESD rating of class 0, customers should lay a conductive mat on the floor, and use foot ground straps. Ionizers are also recommended. All of this equipment must be periodically tested in a recommended process.

Follow ESD precautions to protect against < HBM +/-250V ESD voltage strike.

ESD	Class 0	Up to 250V
Note: Based on JEDEC JESD22-A114-C		

9. RoHS Compliance

RoHS Compliance	Yes
------------------------	------------

■ Assembly Techniques for WLCSP MMICs

10. Handling of WLCSP MMICs in Tape and Reel From

Peel the carrier tape and the top tape off slowly at a rate of 10 mm/s or less to prevent the generation of electro-static discharge. When peeling the tape off, the angle between the carrier tape and the top tape should be kept at 165 to 180 degrees as shown in Fig. 3.

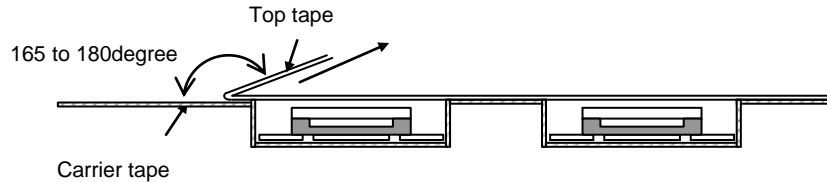

Figure 3

11. Packing

WLCSP products are offered in either the tape and reel or tray shipping configuration. The products are placed with solder bump facing down.

a) Tray Shipment

Each tray contains 100pcs. and minimum order is one tray, and must order in 100pcs. increment

b) Tape and Reel Shipment

Each reel contains 500pcs. and minimum order is one reel, and must order in 500pcs. increment

ORDERING INFORMATION

SMM5145XZ : Tray Shipment : 100pcs. /Tray and, 100pcs. (per Tray) increment.

SMM5145XZT : Tape and Reel Shipment : 500pcs. /Reel, and 500pcs. (per Reel) increment.

Part Number	Order Unit	Packing
SMM5145XZ	100pcs.	100pcs./Tray=100pcs./Packing
SMM5145XZT	500pcs.	500pcs./Reel=500pcs./Packing

- NOTE -

This information is described as reference information based on SEI experimental test like assembly process, PCB and stencil design, Temperature cycle test result and so on.

SEI can not guarantee the quality of WLCSP after the customer's assembly process because assembly and PCB condition is generally different between customer and SEI.

Please check the quality of device (or system) after customer assembles with customer's PCB and assembly process.

For further information please contact:

<http://global-sei.com/Electro-optic/about/office.html>

CAUTION

This product contains **gallium arsenide (GaAs)** which can be hazardous to the human body and the environment. For safety, observe the following procedures:

- Do not put these products into the mouth.
- Do not alter the form of this product into a gas, powder, or liquid through burning, crushing, or chemical processing as these by-products are dangerous to the human body if inhaled, ingested, or swallowed.
- Observe government laws and company regulations when discarding this product. This product must be discarded in accordance with methods specified by applicable hazardous waste procedures.