

■ Features

- High Output Power: Pout=48.0dBm (Typ.)
- High Gain: GL=8.5dB (Typ.)
- High Power Added Efficiency: PAE=32% (Typ.)
- Broad Band: 13.75 to 14.5GHz
- Hermetically Sealed Package

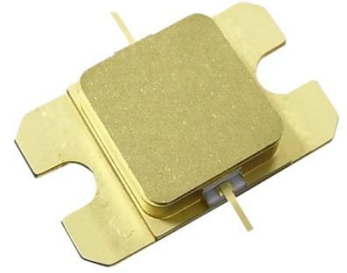

■ Description

The SGK1314-60A is a high power GaN-HEMT that is internally matched for standard communication bands to provide optimum power and gain in a 50ohm system.

ABSOLUTE MAXIMUM RATING (Case Temperature T_c=25 deg.C)

Item	Symbol	Rating	Unit
Drain-Source Voltage	V _{DS}	26	V
Gate-Source Voltage	V _{GS}	-10	V
Total Power Dissipation	P _T	225	W
Storage Temperature	T _{stg}	-55 to +125	deg.C
Channel Temperature	T _{ch}	+250	deg.C
Case Temperature	T _{case}	-40 to +125	deg.C
Input Power	Pin	<=46	dBm

RECOMMENDED OPERATING CONDITION

Item	Symbol	Condition	Limit	Unit
Drain-Source Voltage	V _{DS}		<=24	V
Forward Gate Current	I _{GF}	Rg=51ohm	<=20.2	mA
Reverse Gate Current	I _{GR}	Rg=51ohm	>=-6.4	mA
Channel Temperature	T _{ch}		<+193	deg.C

ELECTRICAL CHARACTERISTICS (Case Temperature T_c=25 deg.C)

Item	Symbol	Condition	Limit			Unit
			Min.	Typ.	Max.	
Saturated Drain Current	I _{DSS}	V _{DS} =10V, V _{GS} =0V	-	21.0	-	A
Trans Conductance	G _m	V _{DS} =24V, I _{DS} =1.8A	-	6.2	-	S
Pinch-off Voltage	V _p	V _{DS} =10V, I _{DS} =1.8mA	-	-3.6	-	V
Frequency Range	f		13.75	-	14.5	GHz
Output Power at Pin=43dBm	Pout		47.0	48.0	-	dBm
Linear Gain at Pin=27dBm	GL	V _{DS} =24V(typ.)	7.5	8.5	-	dB
Power Gain at Pout=44.5dBm	GP	I _{DS(DC)} =1.8A(typ.)	6.0	7.0	-	dB
Drain Current at Pin=43dBm	I _{DSR}	Vgs-constant	-	6.6	9.1	A
Power Added Efficiency at Pin=43dBm	PAE		-	32	-	%
Gain Flatness at Pin=27dBm	ΔG		-	-	1.6	dB
3rd Order Intermodulation Distortion	IM ₃	f=13.75GHz, 14.5GHz Δf=10MHz, 2-tone Test Pout=41.5dBm (S.C.L.)	-25.0	-30.0	-	dBc
Thermal Resistance	R _{th}	Channel to Case (T _c =25deg.C, P _{diss} =43.2W)	-	0.8	1.0	deg.C/W

S.C.L. : Single Carrier Level

CASE STYLE	IBK
RoHS Compliance	YES
ESD	Class 2
	2000V to < 4000V

Note : Based on ANSI/ESDA/JEDEC JS-001-2012(C=100pF, R=1.5kohm)

● Package Out line

Case Style : IBK

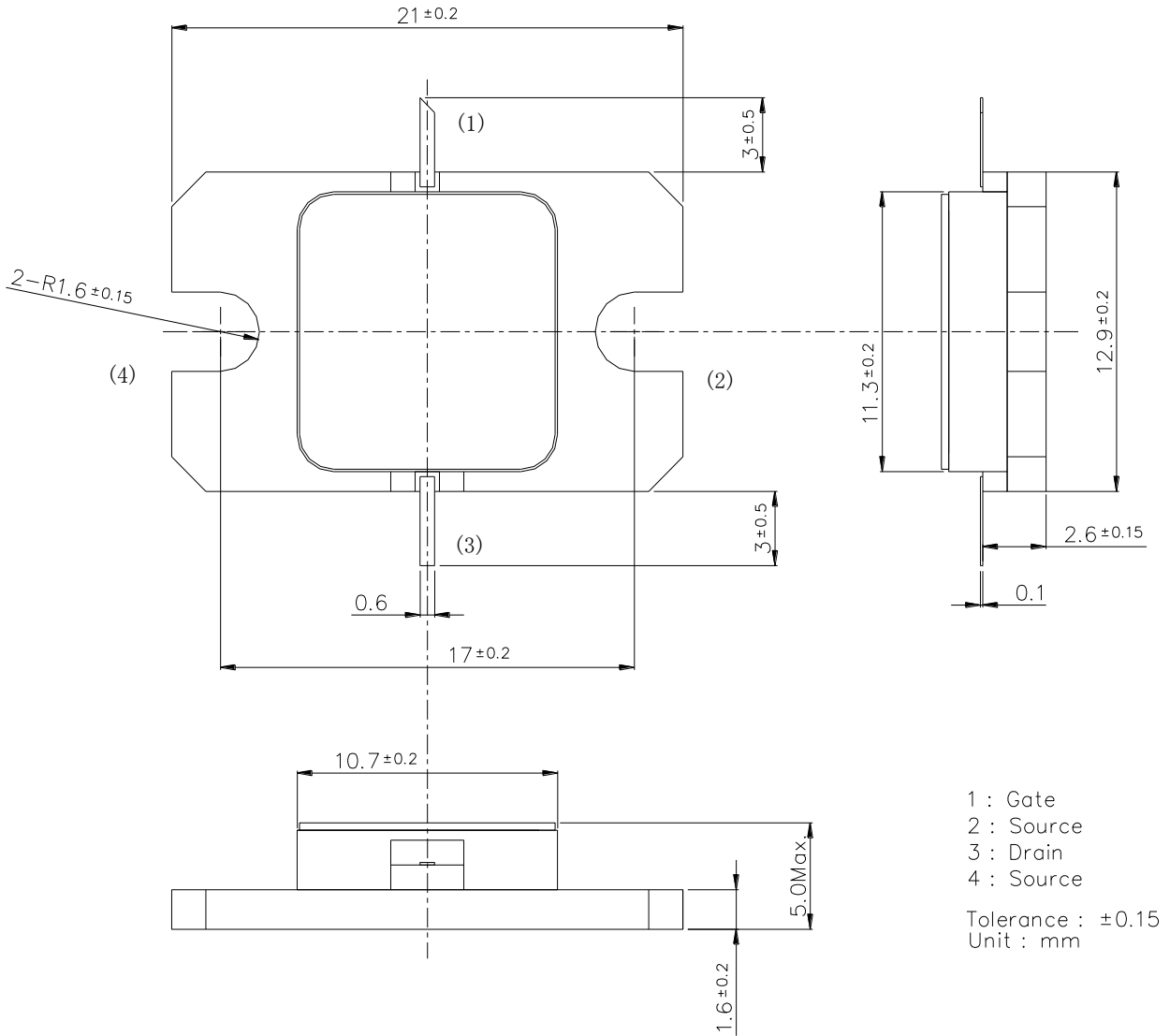

For Safety, Observe the Following Procedures Environmental Management

- Do not put this product into the mouth.
- Do not alter the form of this product into a gas, powder, or liquid through burning, crushing, or chemical processing as these by-products are dangerous to the human body if inhaled, ingested, or swallowed.
- Respect all applicable laws of the country when discarding this product.
This product must be disposed in accordance with methods specified by applicable hazardous waste procedures.

Any information, such as descriptions of a function and examples of application circuits, in this document are presented solely as a reference for the purpose to show examples of operations and uses of Sumitomo Electric semiconductor device(s); Sumitomo Electric does not warrant the proper operation of the device(s) with respect to its use based on such information. When the user develops equipment incorporating the device(s) based on such information, they must assume full responsibility arising out of using such information. Sumitomo Electric assumes no liability for any damages whatsoever arising out of the use of the information.

Any information in this document, including descriptions of function and schematic diagrams, shall not be construed as a license for the use or exercise of any intellectual property right, such as patent right or copyright, or any other right of Sumitomo Electric or any third party nor does Sumitomo Electric warrant non-infringement of any third-party's intellectual property right or other right by using such information. Sumitomo Electric assumes no liability for any infringement of the intellectual property rights or other rights of third parties which would result from the use of information contained herein.

The products described in this document are designed, developed and manufactured as contemplated for general use, including, without limitation, ordinary industrial use, general office use, personal use, and household use, but are not designed, developed and manufactured as contemplated (1) for use accompanying fatal risks or dangers that, unless extremely high safety is secured, could have a serious effect to the public, and could lead directly to death, personal injury, severe physical damage or other loss (i.e., nuclear reaction control in nuclear facility, aircraft flight control, air traffic control, mass transport control, medical life support system, missile launch control in weapon system), or (2) for use requiring extremely high reliability (i.e., submersible repeater and artificial satellite). Please note that Sumitomo Electric will not be liable to the user and/or any third party for any claims or damages arising from the aforementioned uses of the products.

Any semiconductor devices have an inherent chance of failure. You must protect against injury, damage or loss from such failures by incorporating safety design measures into your facility and equipment such as redundancy, fire protection, and prevention of excessive current levels and other abnormal operating conditions.

If any products described in this document represent goods or technologies subject to certain restrictions on export under the Foreign Exchange and Foreign Trade Law of Japan, the prior authorization of the Japanese government will be required for export of those products from Japan.

<http://www.sedi.co.jp/>

ATTENTION

Information in this document is subject to change without notice.