

### ■ Features

- High Output Power: P1dB=36.0dBm (Typ.)
- High Gain: G1dB=11.0dB (Typ.)
- High Power Added Efficiency: PAE=36% (Typ.)
- Broad Band: Frequency=6.4 to 7.2GHz
- Internally Matched
- Plastic Package for SMT applications

### ■ Description

The ELM6472-4PS is a power GaAs FET that is internally matched for standard communication bands to provide optimum power and gain.



#### ABSOLUTE MAXIMUM RATING (Case Temperature T<sub>c</sub>=25 deg.C)

Item	Symbol	Rating	Unit
Drain-Source Voltage	V <sub>DS</sub>	15	V
Gate-Source Voltage	V <sub>GS</sub>	-5	V
Total Power Dissipation	P <sub>T</sub>	27.3	W
Storage Temperature	T <sub>stg</sub>	-40 to +125	deg.C
Channel Temperature	T <sub>ch</sub>	175	deg.C

#### RECOMMENDED OPERATING CONDITION

Item	Symbol	Condition	Limit	Unit
Drain-Source Voltage	V <sub>DS</sub>		<10	V
Forward Gate Current	I <sub>GF</sub>	Rg=100ohm	<+16	mA
Reverse Gate Current	I <sub>GR</sub>	Rg=100ohm	> -2.2	mA
Channel Temperature	T <sub>ch</sub>		155	deg.C

#### ELECTRICAL CHARACTERISTICS (Case Temperature T<sub>c</sub>=25 deg.C)

Item	Symbol	Condition	Limit			Unit
			Min.	Typ.	Max.	
Saturated Drain Current	I <sub>DSS</sub>	VDS=5V, VGS=0V	-	1700	2600	mA
Trans Conductance	g <sub>m</sub>	VDS=5V, IDS=1100mA	-	1700	-	mS
Pinch-off Voltage	V <sub>p</sub>	VDS=5V, IDS=85mA	-0.5	-1.5	-3.0	V
Gate-Source Breakdown Voltage	V <sub>GSO</sub>	IGS=-85uA	-5.0	-	-	V
Output Power at 1dB G.C.P.	P <sub>1dB</sub>	VDS=10V Ids(DC)=1100mA(typ.) f=6.4 to 7.2 GHz	35.0	36.0	-	dBm
Power Gain at 1dB G.C.P.	G <sub>1dB</sub>		9.5	11.0	-	dB
Drain Current	I <sub>DSR</sub>		-	1100	1300	mA
Power Added Efficiency	PAE		-	36.0	-	%
Gain Flatness	ΔG		-	-	1.2	dB
3rd Order Inter Modulation Distortion	IM <sub>3</sub>		f=7.2GHz Δf=10MHz, 2-tone Test Pout=25.5dBm (S.C.L.)	-40.0	-43.0	-
Thermal Resistance	R <sub>th</sub>	Channel to Case	-	4.5	5.5	deg.C/W
Channel Temperature Rise	ΔT <sub>ch</sub>	(V <sub>DS</sub> × I <sub>DSR</sub> - Pout + Pin) × R <sub>th</sub>	-	-	71.5	deg.C

G.C.P. : Gain Compression Point, S.C.L. : Single Carrier Level

CASE STYLE	I2C
RoHS Compliance	YES
ESD	Class 3A
MSL	2
	4000V to < 8000V
	One year after opening the packing

Note : Based on ANSI/ESDA/JEDEC JS-001-2012(C=100pF, R=1.5kohm)

**Ordering Information**

<b>Model Type</b>	<b>MOQ</b>	<b>MOU</b>	<b>Packing Style</b>
ELM6472-4PS	15pcs	No Limitation	50pcs-max./Tray , 1Tray-max./Packing
ELM6472-4PST	500pcs	500pcs	24mm width Tape (500pcs/Reel)

\* MOQ stands for Minimum Order Quantity.

\* MOU stands for Minimum Order Unit size.

**Note**

- This device will not be delivered with test data but tested pass/fail 100% against DC and RF specifications.
- NO liquid cleaning process is suitable for this device. (including de-ionized water or solvent)

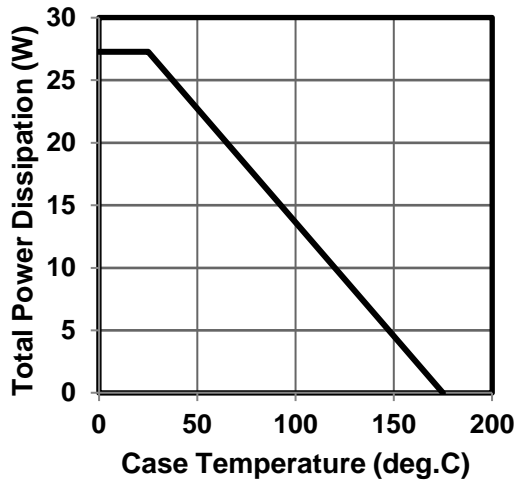
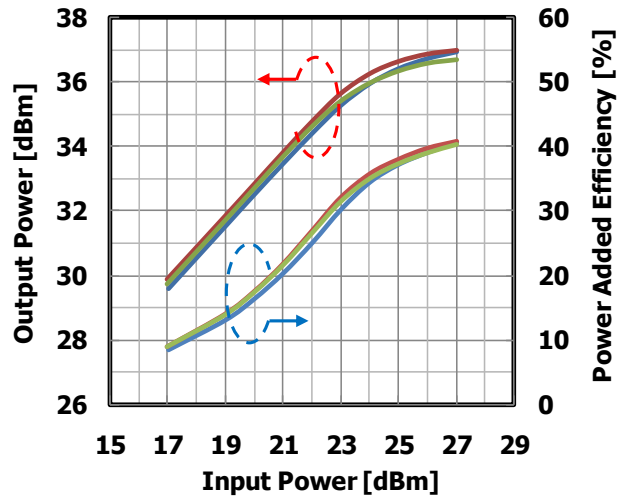
**RF Characteristics**
**Power Derating Curve**

**Input Power vs. Output Power and Power Added Efficiency**  
 $V_{DS}=10V, I_{DS(DC)}=1100mA$ 

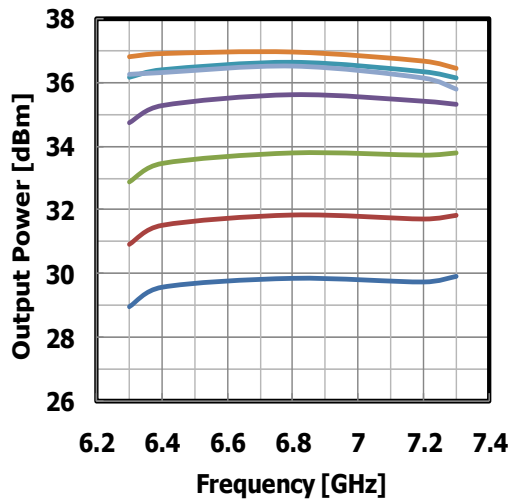
— 6.4 GHz — 6.8 GHz — 7.2 GHz

**Output Power vs. Frequency**  
 $V_{DS}=10V, I_{DS(DC)}=1100mA$ 

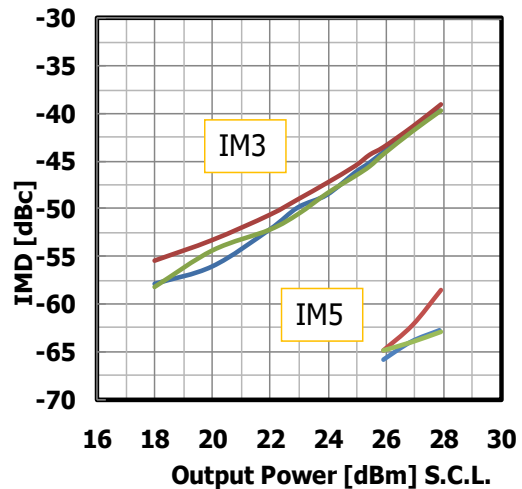
— 17 dBm — 19 dBm — 21 dBm — 23 dBm  
 — 25 dBm — 27 dBm — P1dB

**IMD vs. Output Power**  
 $V_{DS}=10V, I_{DS(DC)}=1100mA$ 

— 6.4 GHz — 6.8 GHz — 7.2 GHz

**● RF Characteristics**

**Input Power vs. Output Power, Power Added Efficiency by Drain Voltage**  
**IDS(DC)=1100mA @6.4GHz**

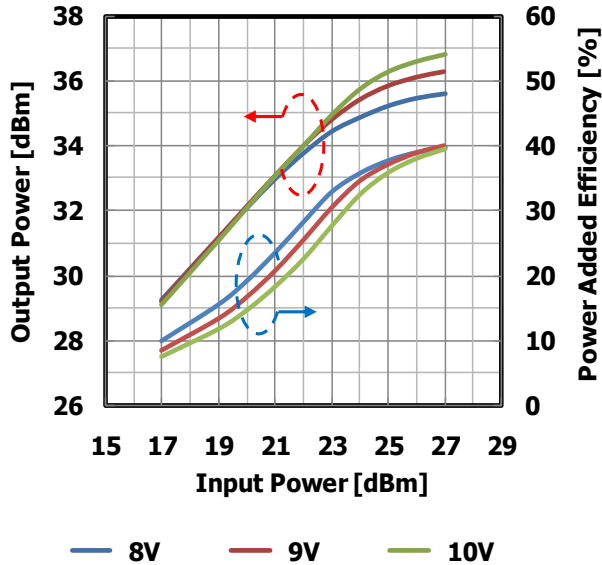

**Input Power vs. Output Power, Power Added Efficiency by Drain Voltage**  
**IDS(DC)=1100mA @6.8GHz**

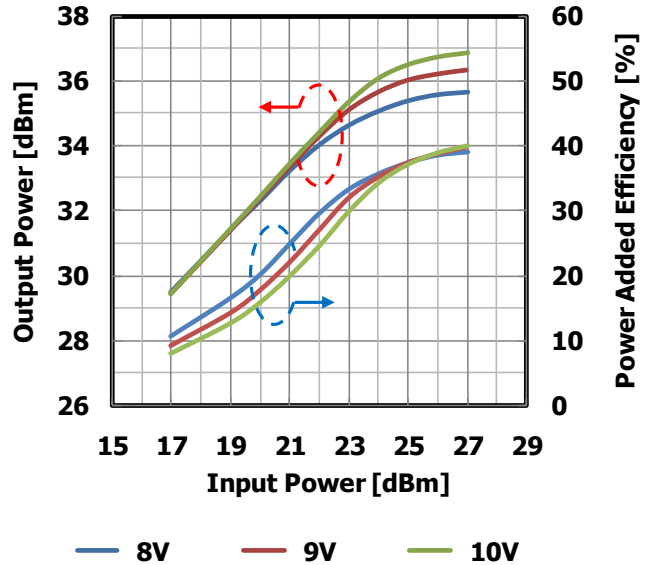

**Input Power vs. Output Power, Power Added Efficiency by Drain Voltage**  
**IDS(DC)=1100mA @7.2GHz**

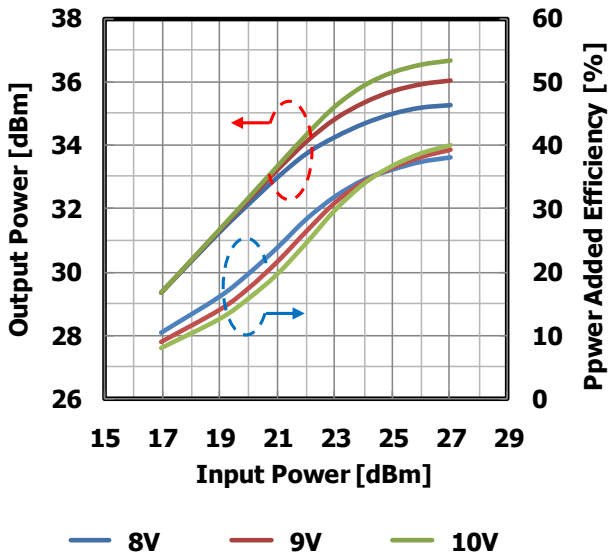

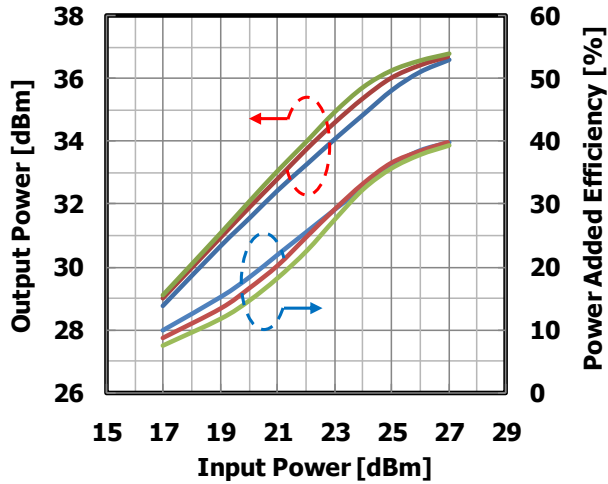
**● RF Characteristics**
**Input Power vs. Output Power, Power Added Efficiency by Quiescent Drain Current  
VDS=10V @6.4GHz**

— 700mA — 900mA — 1100mA

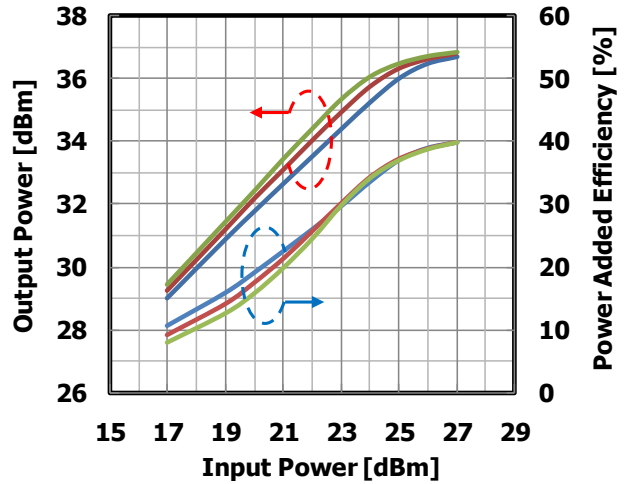
**Input Power vs. Output Power, Power Added Efficiency by Quiescent Drain Current  
VDS=10V @6.8GHz**

— 700mA — 900mA — 1100mA

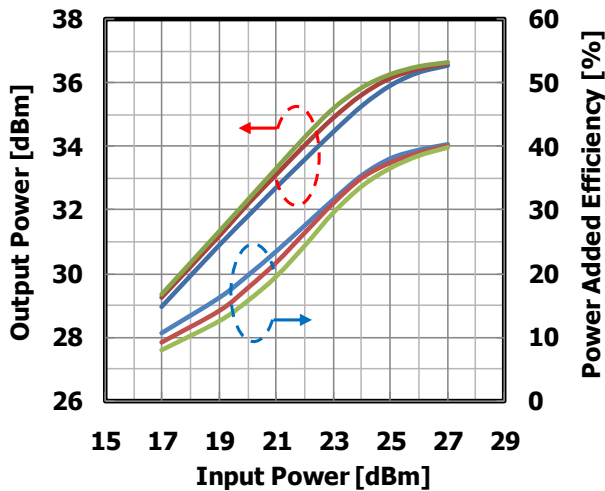
**Input Power vs. Output Power, Power Added Efficiency by Quiescent Drain Current  
VDS=10V @7.2GHz**

— 700mA — 900mA — 1100mA

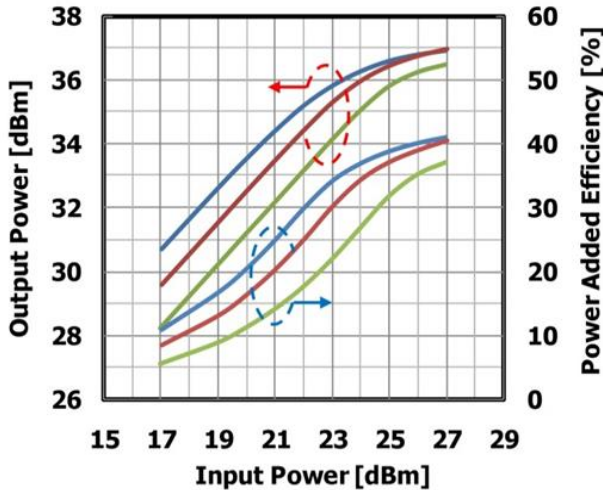
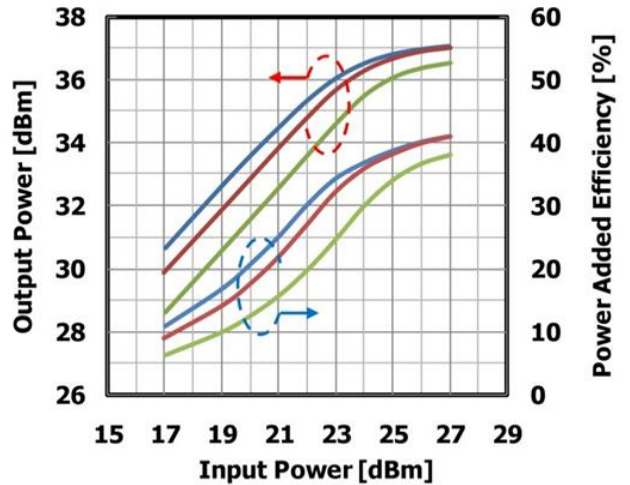
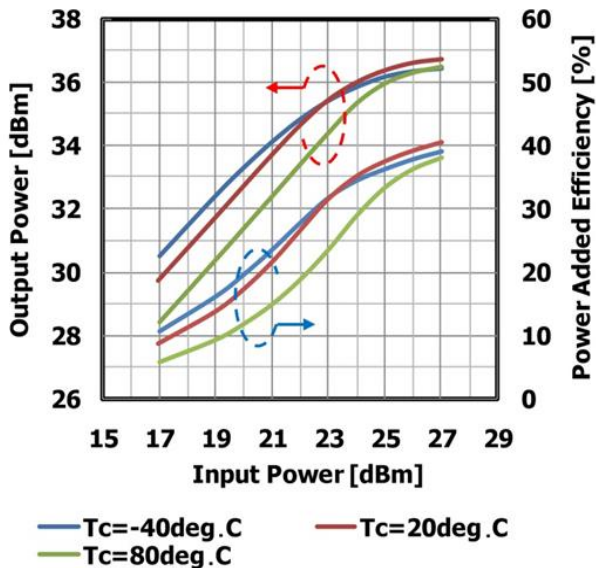
**● RF Characteristics**
**Input Power vs. Output Power, Power Added Efficiency by Temperature  
VDS=10V @6.4GHz**

**Input Power vs. Output Power, Power Added Efficiency by Temperature  
VDS=10V @6.8GHz**

**Input Power vs. Output Power, Power Added Efficiency by Temperature  
VDS=10V @7.2GHz**

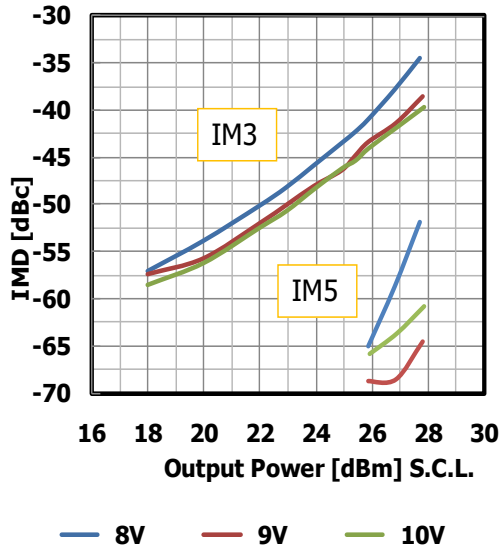
**● RF Characteristics**

**IMD Performance vs. Output Power  
by Drain Voltage**  
**IDS(DC)=1100mA @6.4GHz**

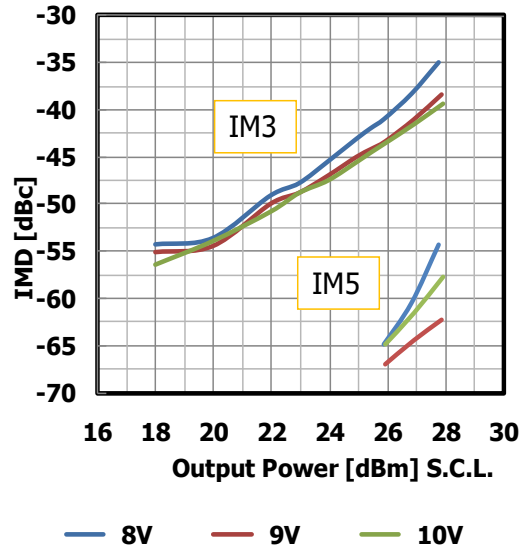

**IMD Performance vs. Output Power  
by Drain Voltage**  
**IDS(DC)=1100mA @6.8GHz**



**IMD Performance vs. Output Power  
by Drain Voltage**  
**IDS(DC)=1100mA @7.2GHz**

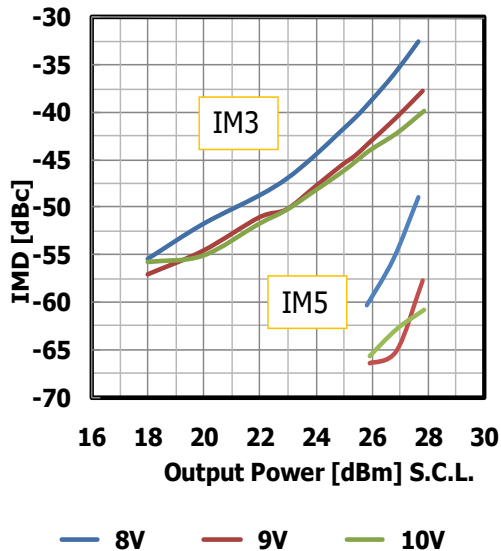

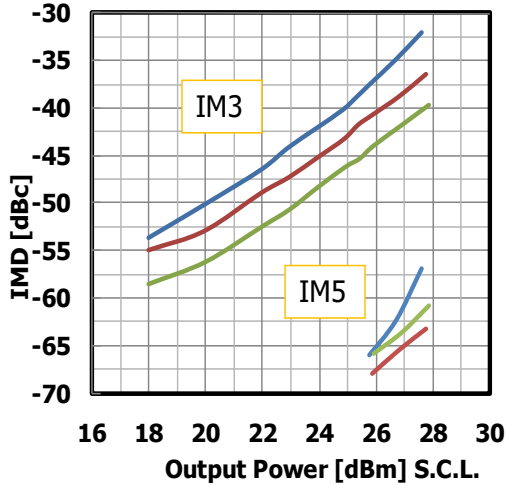
**● RF Characteristics**
**IMD Performance vs. Output Power  
by Quiescent Drain Current  
VDS=10V @6.4GHz**

— 700mA — 900mA — 1100mA

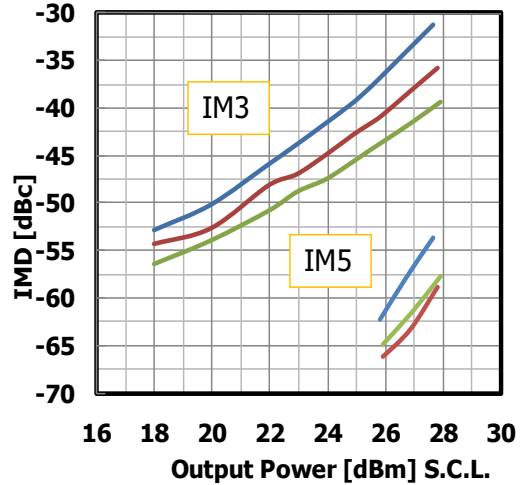
**IMD Performance vs. Output Power  
by Quiescent Drain Current  
VDS=10V @6.8GHz**

— 700mA — 900mA — 1100mA

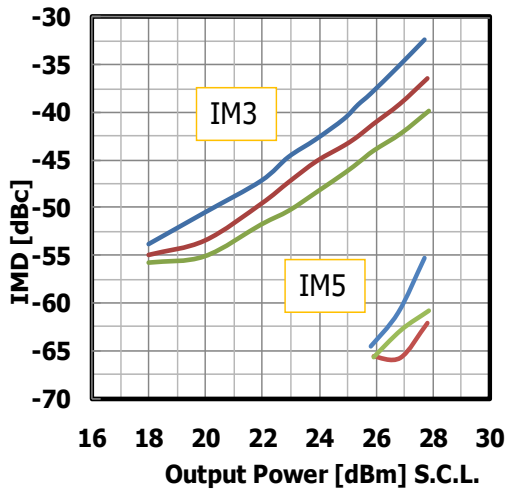
**IMD Performance vs. Output Power  
by Quiescent Drain Current  
VDS=10V @7.2GHz**

— 700mA — 900mA — 1100mA

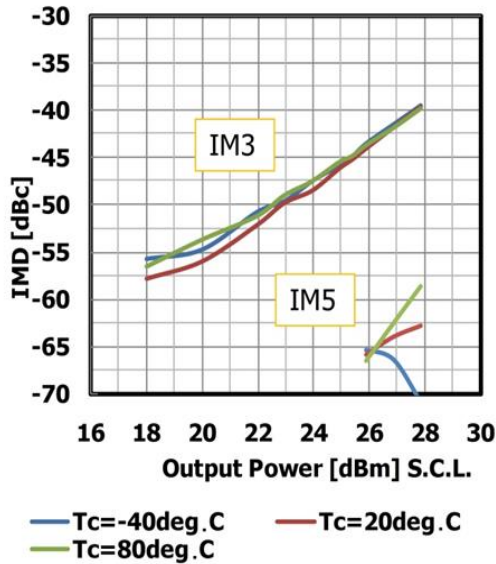
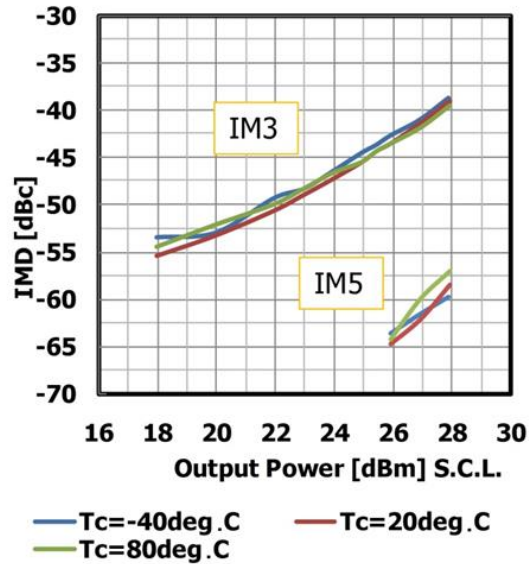
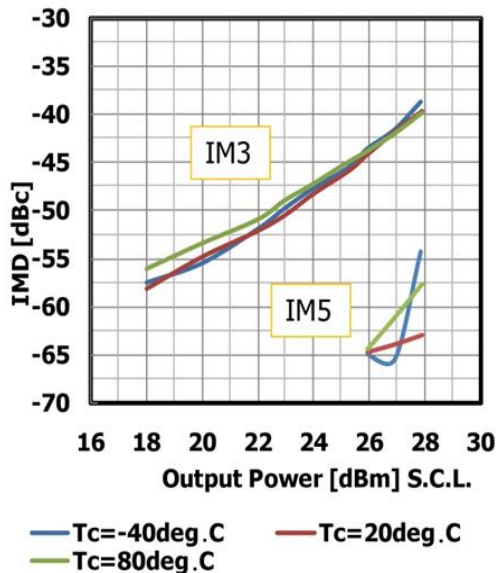

**● RF Characteristics**
**IMD Performance vs. Output Power  
by Temperature  
VDS=10V @6.4GHz**

**IMD Performance vs. Output Power  
by Temperature  
VDS=10V @6.8GHz**

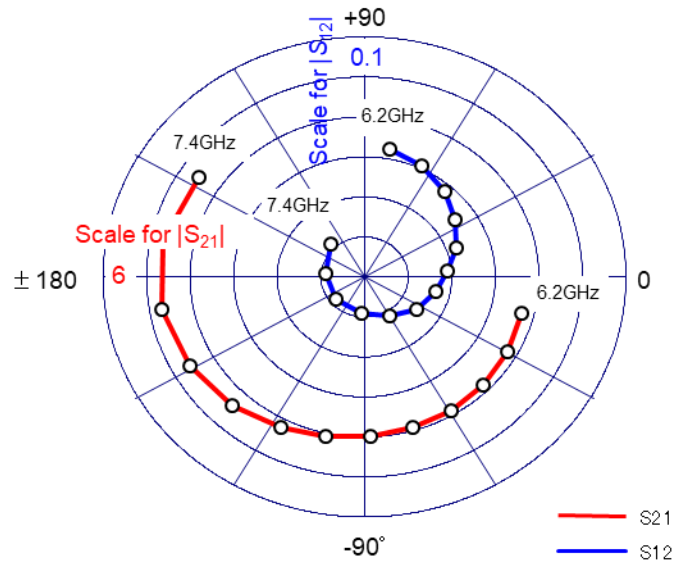
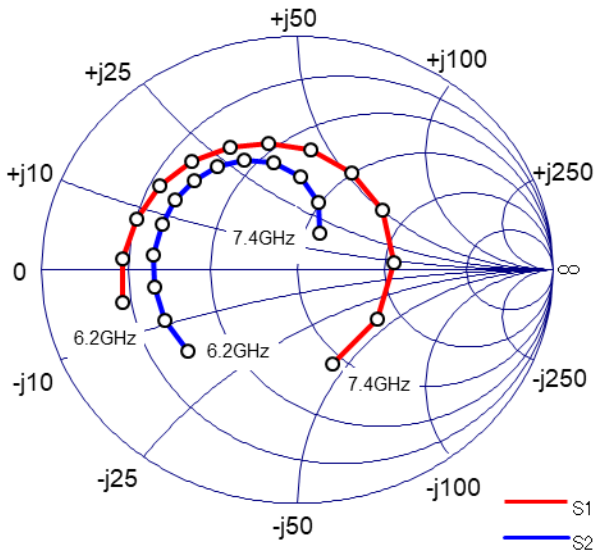
**IMD Performance vs. Output Power  
by Temperature  
VDS=10V @7.2GHz**

## ● S-Parameter

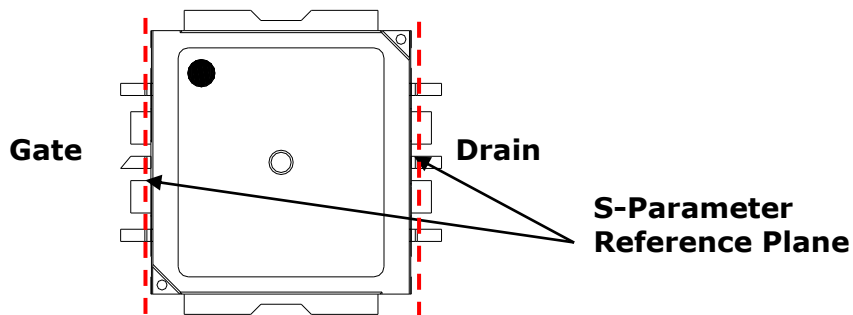

Frequency (MHz)	S11		S21		S12		S22	
	MAG	ANG	MAG	ANG	MAG	ANG	MAG	ANG
6200	0.696	-168.6	3.710	-14.2	0.054	79.8	0.553	-140.7
6300	0.683	175.8	3.777	-29.7	0.051	64.6	0.558	-157.2
6400	0.664	160.9	3.840	-44.6	0.047	49.5	0.562	-172.8
6500	0.644	146.2	3.877	-59.2	0.042	34.5	0.564	173.3
6600	0.620	131.4	3.924	-73.6	0.037	19.1	0.564	159.7
6700	0.587	116.5	3.981	-87.9	0.032	4.7	0.562	147.6
6800	0.554	101.4	4.083	-102.4	0.028	-12.7	0.556	136.5
6900	0.516	83.9	4.218	-117.2	0.024	-33.6	0.540	125.0
7000	0.468	63.1	4.412	-133.4	0.019	-59.3	0.513	113.6
7100	0.419	37.5	4.590	-151.0	0.015	-95.1	0.467	101.4
7200	0.381	4.8	4.735	-170.2	0.014	-140.1	0.399	88.4
7300	0.380	-33.9	4.727	168.6	0.015	173.6	0.303	74.4
7400	0.426	-71.1	4.535	146.8	0.019	133.6	0.183	60.9



● Package Out line  
Case Style : I2C

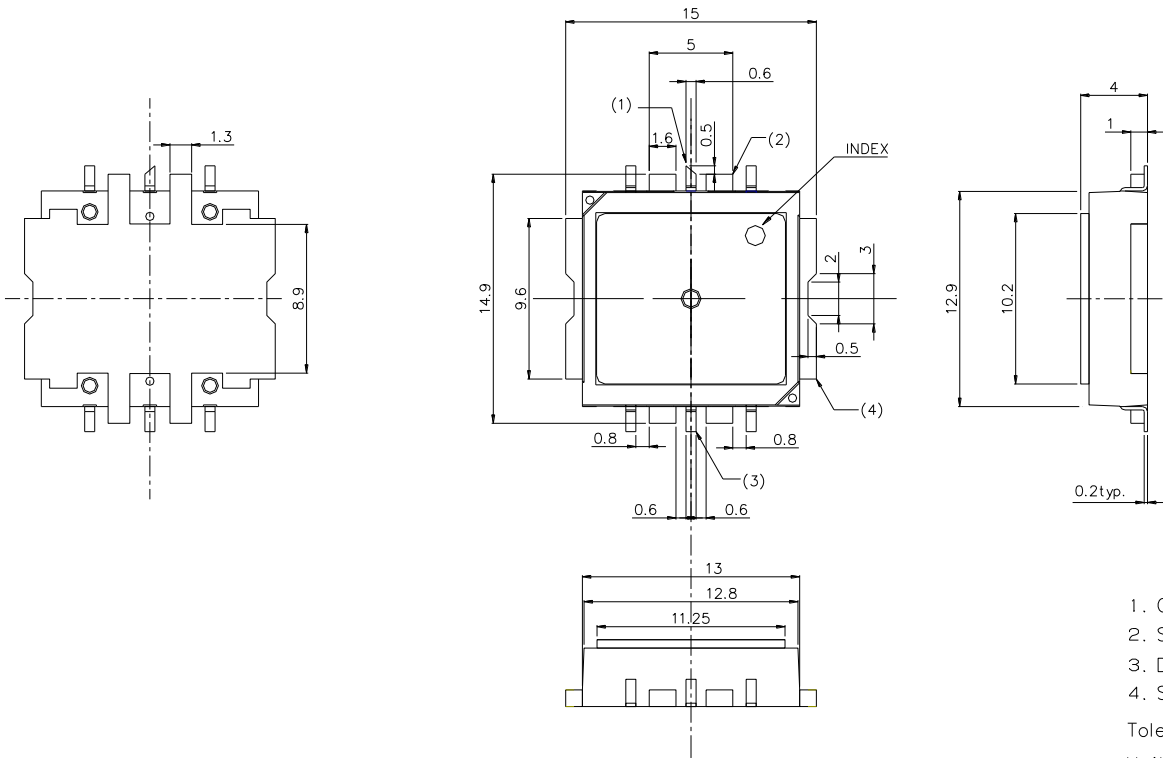

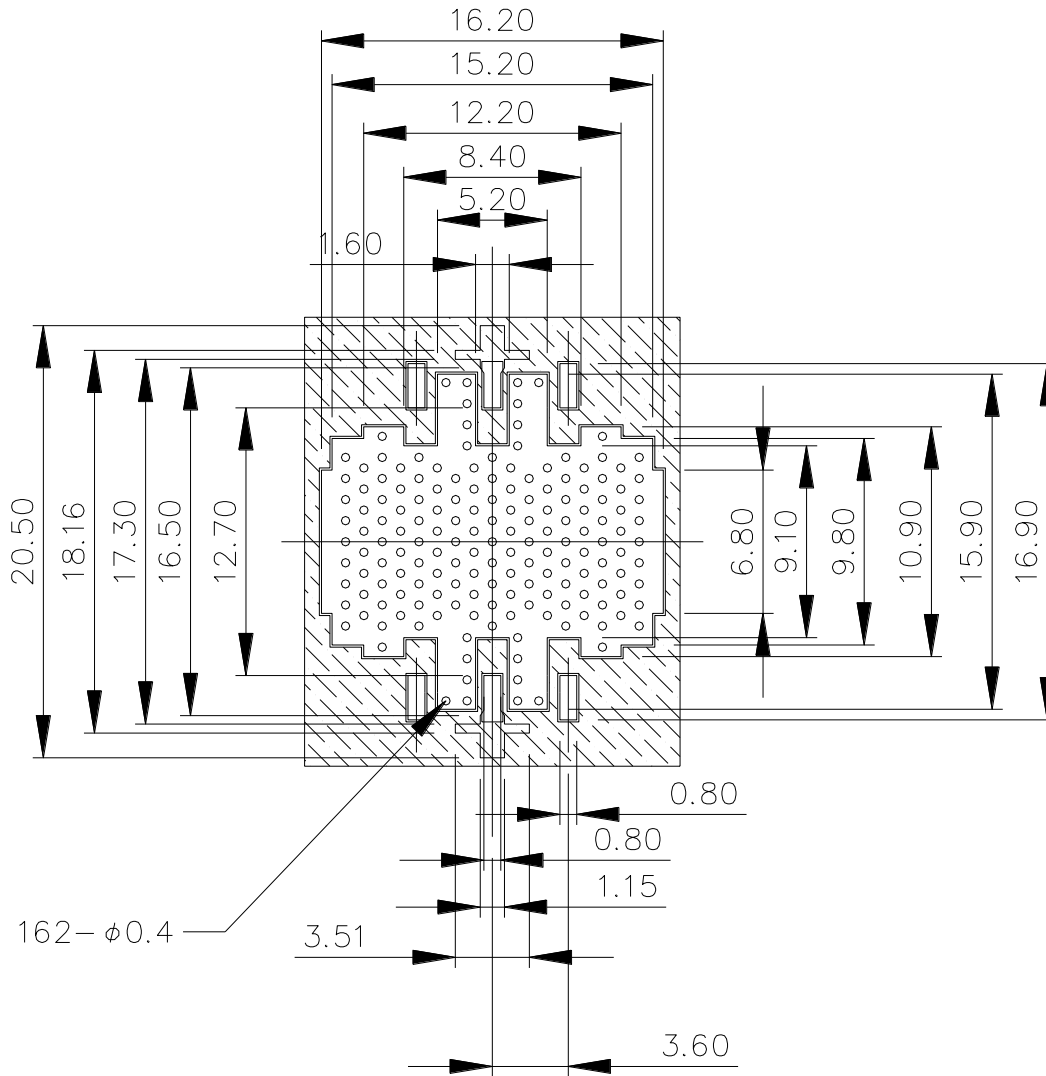
**● PCB Pads and Solder-Resist Pattern**

Notes :

1. Laminate : Rogers Corporation R04003, Thickness  $t=0.508\text{mm}$ , Cu Foil  $18\mu\text{m}$ .  
 Finish to copper foil : Ni  $0.1\mu\text{m}$  min. / Au  $0.1\mu\text{m}$  (Both side).
2.  : Resist

**● Package Marking**

Lot Number : 1st: Year Code  
 2nd: Month Code

**Year Code**

Code	Y	Z	A	B	C	D	E	F	G	H	I	J
Year	2016	2017	2018	2019	2020	2021	2022	2023	2024	2025	2026	2027

**Month Code**

Code	H	M	N	P	R	S	T	U	W	X	Y	Z
Month	1	2	3	4	5	6	7	8	9	10	11	12

PKG	Marking	Type Number	Part Number
I2C	(ex.I2C PKG) 	ELM*****-*** SGK*****-***  ex. ELM5964-7PS SGK5872-20A	*****-*** *****-***  5964-7PS 5872-20A

- **JEDEC Tray Dimension  
(Part No:ELM6472-4PS)**

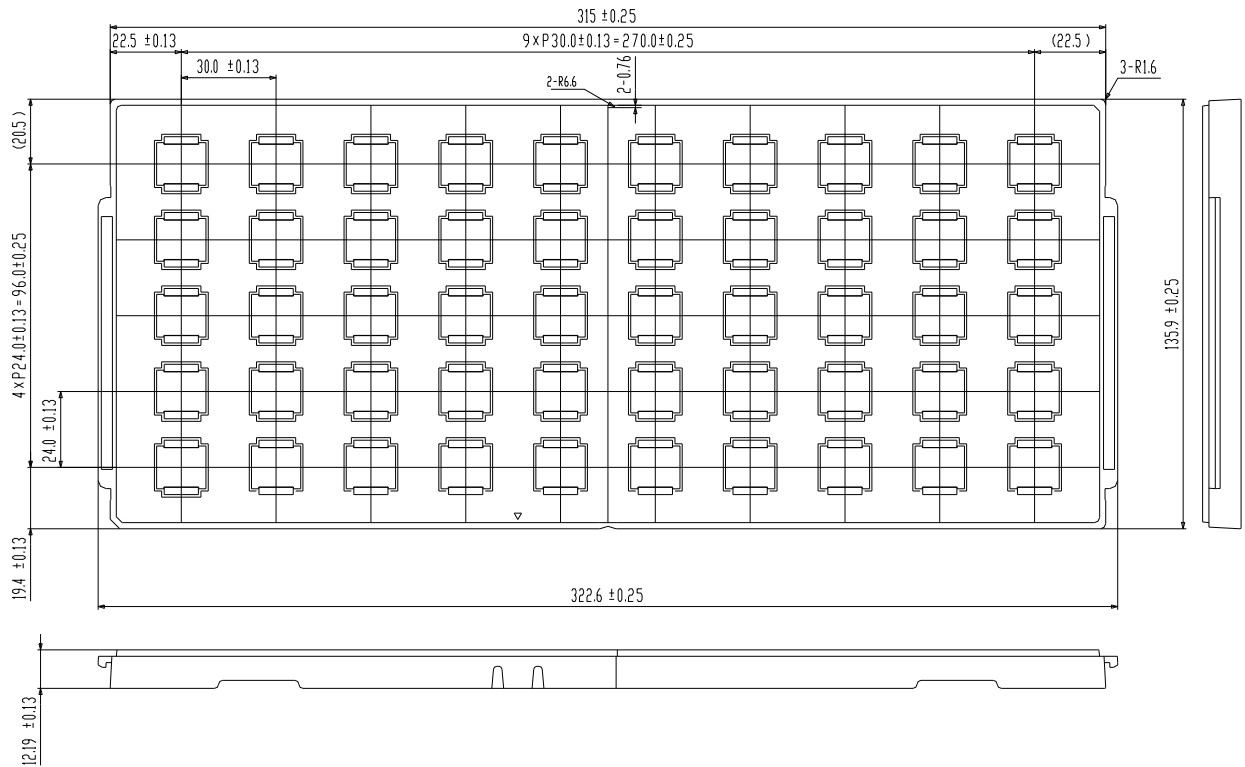

● **Tape/Reel Configuration**  
**(Part No:ELM6472-4PST)**

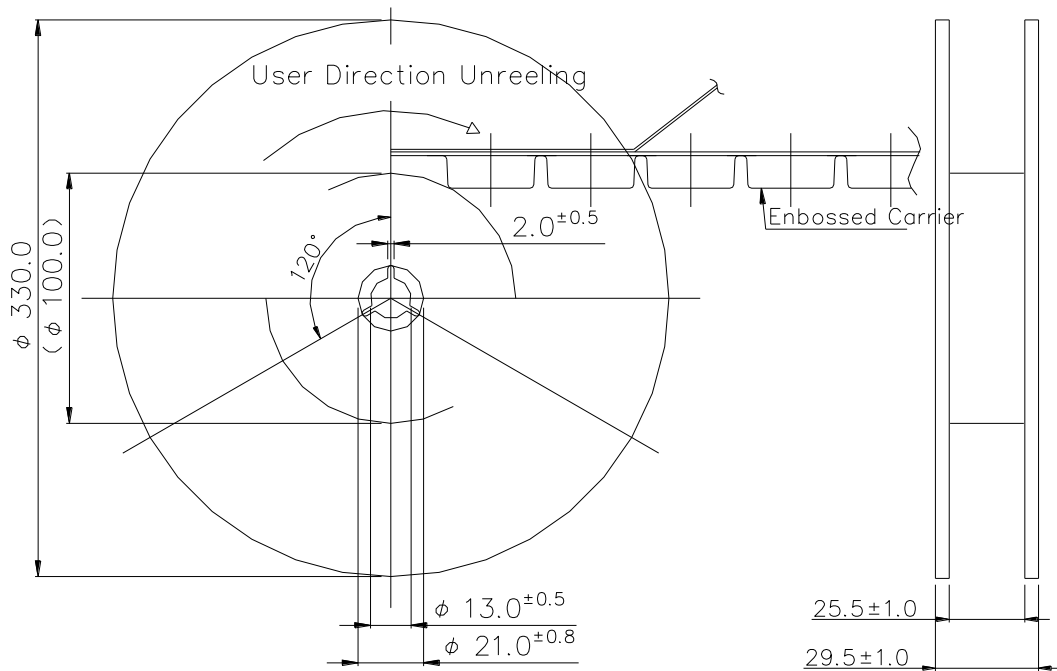
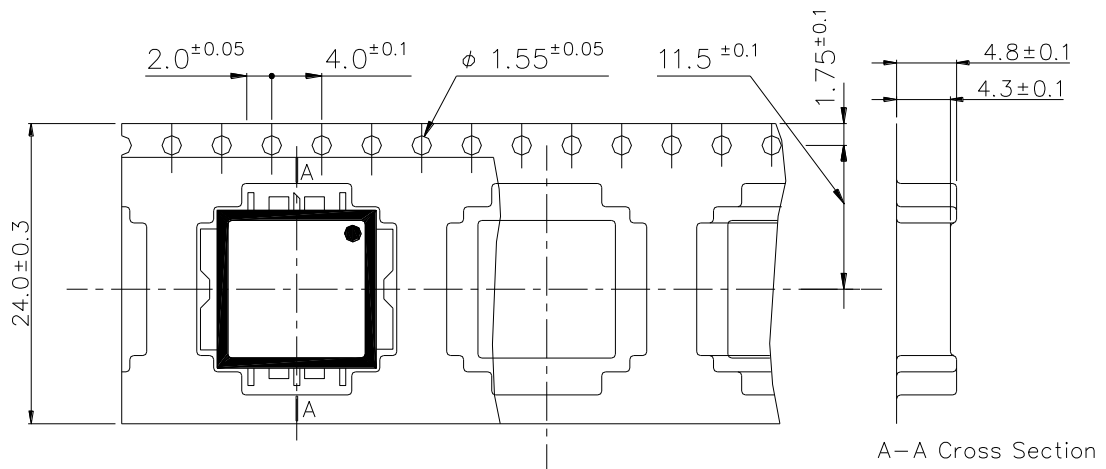

Quantity: 500pcs/tape  
Tape Material: Conductive PS

(unit in mm)

## ● Mounting Instructions for Package for Lead-free solder

### Mounting Condition

For soldering, Lead-free solder (Sn-3.0Ag-0.5Cu)\*1 or equivalent shall be used.

1. The example solder is a tin-rich alloy with 3.0% silver and 0.5% copper, often called Sn 96 for its approximate Tin content.
2. A rosin type flux with chlorine content of 0.2% or less shall be used. The rosin flux with low halogen content is recommended. When soldering, use the following time/ temperature profile with any of the methods listed for acceptable solder joints.
3. Make sure the devices have been properly prepared with flux prior soldering.

### \* Reflow soldering method (Infrared reflow / Heat circulation reflow / Hot plate reflow);

Limit solder to 3 reflow cycles because resin is used in the modules manufacturing process.

Excessive reflow will effect the resin resulting in a potential failure or latent defect.

The recommended reflow temperature profile is shown below. The temperature of the reflow profile must be measured at the device lead.

### ● Reflow temperature profile and condition:

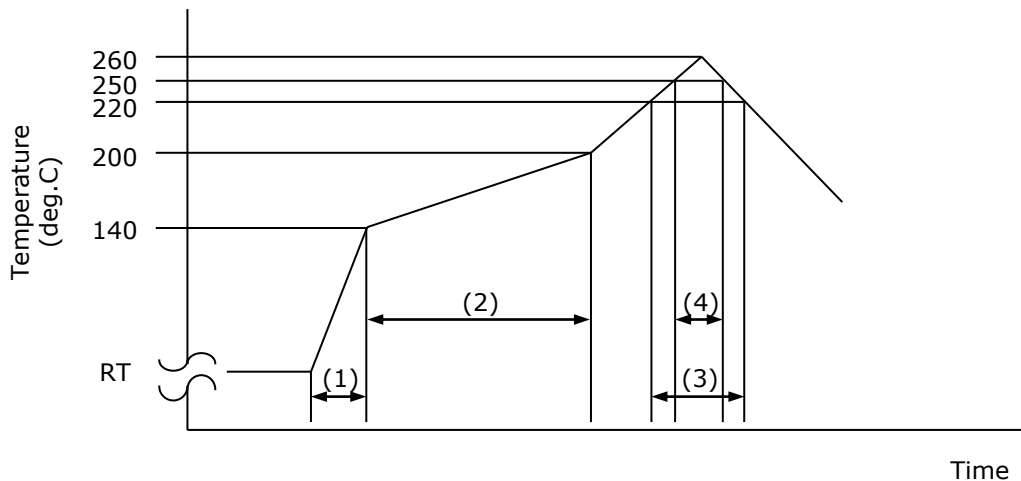

- (1). Temperature rise: 3 deg.C/seconds.
  - (2). Preheating: 150 to 200 deg.C, 60 to 180seconds.
  - (3). Main heating: 220 deg.C, 60 seconds max.
  - (4). Main heating: 260 deg.C max., more than 250 deg.C, 20 to 40 seconds max.
- \* Measurement point: Device Heat-sink (Source Pin).

1. The above-recommended conditions were confirmed using the manufacturer's equipment and materials. However, when soldering these products, the soldering condition should be verified by customer using their own particular equipment and materials.

## ● Cleaning

Avoid washing of the device after soldering by reflow method due to the risk of liquid absorption by the resin used in this part.



## ● Humidity Lifetime and fit rate for ELMxxxx-4PST

The following graph shows the effect of moisture on lifetime (moisture resistance) for the ELMxxxx-4PST. Each graph indicates the MTTF and failure rate prediction (Confidential Level = 90 %) which calculated from the results of highly accelerated temperature and humidity stress test (HAST).

Representative of device type : ELM7179-4PST

Subject of device type : ELMxxxx-4PST

### Field environmental conditions for operation

If the **ELMxxxx-4PST** is installed in a non-hermetic environment, please refer to the following recommendations and notes for design with, and assembly and use of our products.

- Note 1. When drain current cuts off, it should be cut off by drain bias, and not cut off by gate bias only. The humidity lifetime becomes shorter in case of the gate-only cut off operation due to electric field strength interacting with humidity.
- Note 2. **ELMxxxx-4PST** should be used under the environment conditions of no dew condensation. These plots do not apply in the case of liquid absorbed into the resin, whether applied to the part in assembly or as condensate in the application.

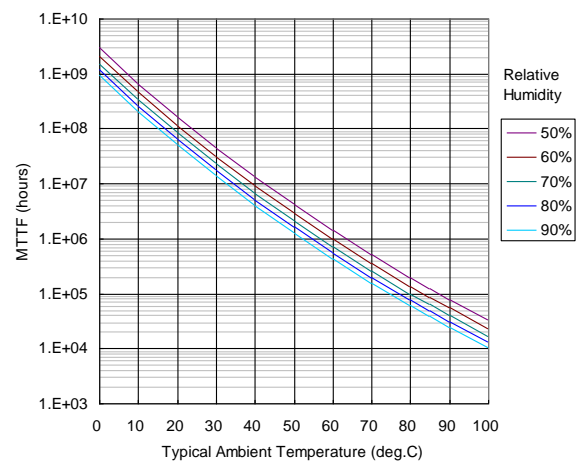
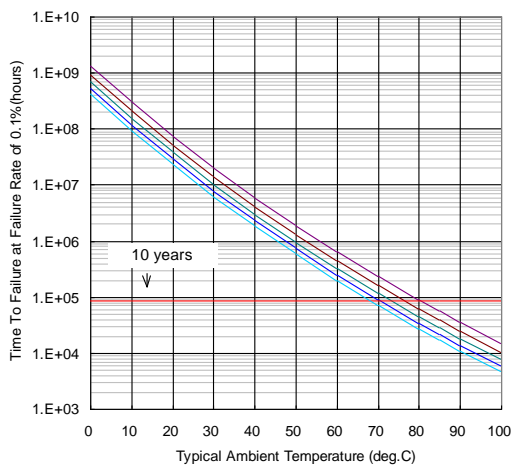

## **For Safety, Observe the Following Procedures Environmental Management**

- Do not put this product into the mouth.
- Do not alter the form of this product into a gas, powder, or liquid through burning, crushing, or chemical processing as these by-products are dangerous to the human body if inhaled, ingested, or swallowed.
- Respect all applicable laws of the country when discarding this product.  
This product must be disposed in accordance with methods specified by applicable hazardous waste procedures.

Any information, such as descriptions of a function and examples of application circuits, in this document are presented solely as a reference for the purpose to show examples of operations and uses of Sumitomo Electric semiconductor device(s); Sumitomo Electric does not warrant the proper operation of the device(s) with respect to its use based on such information. When the user develops equipment incorporating the device(s) based on such information, they must assume full responsibility arising out of using such information. Sumitomo Electric assumes no liability for any damages whatsoever arising out of the use of the information.

Any information in this document, including descriptions of function and schematic diagrams, shall not be construed as a license for the use or exercise of any intellectual property right, such as patent right or copyright, or any other right of Sumitomo Electric or any third party nor does Sumitomo Electric warrant non-infringement of any third-party's intellectual property right or other right by using such information. Sumitomo Electric assumes no liability for any infringement of the intellectual property rights or other rights of third parties which would result from the use of information contained herein.

The products described in this document are designed, developed and manufactured as contemplated for general use, including, without limitation, ordinary industrial use, general office use, personal use, and household use, but are not designed, developed and manufactured as contemplated (1) for use accompanying fatal risks or dangers that, unless extremely high safety is secured, could have a serious effect to the public, and could lead directly to death, personal injury, severe physical damage or other loss (i.e., nuclear reaction control in nuclear facility, aircraft flight control, air traffic control, mass transport control, medical life support system, missile launch control in weapon system), or (2) for use requiring extremely high reliability (i.e., submersible repeater and artificial satellite). Please note that Sumitomo Electric will not be liable to the user and/or any third party for any claims or damages arising from the aforementioned uses of the products.

Any semiconductor devices have an inherent chance of failure. You must protect against injury, damage or loss from such failures by incorporating safety design measures into your facility and equipment such as redundancy, fire protection, and prevention of excessive current levels and other abnormal operating conditions.

If any products described in this document represent goods or technologies subject to certain restrictions on export under the Foreign Exchange and Foreign Trade Law of Japan, the prior authorization of the Japanese government will be required for export of those products from Japan.

<http://www.sedi.co.jp/>

### **ATTENTION**

Information in this document is subject to change without notice.